

TELECOMMUNICATIONS END-TO-END SYSTEMS MONITORING ON TOPEX/POSEIDON: '1'001.S AND TECHNIQUES

Bruno J. Calanche
Jet Propulsion Laboratory
California Institute of Technology
Pasadena, California, USA

ABSTRACT

The TOPEX/Poseidon Project Satellite Performance Analysis Team's (SPAT) roles and responsibilities have grown to include functions that are typically performed by other teams on JPL Flight Projects. In particular, SPAT Telecommunication's role has expanded beyond the nominal function of monitoring, assessing, characterizing, and trending the spacecraft (S/C) RF/Telecom subsystem to one of End-to-End Information Systems (EEIS) monitoring. This has been accomplished by taking advantage of the spacecraft and ground data system structures and protocols.

By processing both the received spacecraft telemetry minor frame ground generated CRC flags and NASCOM block poly error flags, bit error rates (BER) for each link segment can be determined. This provides the capability to characterize the separate link segments, determine science data recovery, and perform fault/anomaly detection and isolation. By monitoring and managing the links, TOPEX has successfully recovered --99.9% of the science data with an integrity (BER) of better than 1×10^{-6} .

This paper presents the algorithms used to process the above flags and the techniques used for EEIS monitoring.

Key words: Telecom OPS, Link Monitoring and Management, End-to-End Information Systems (EEIS) Monitoring, Data Recovery and Integrity.

1. INTRODUCTION

TOPEX/Poseidon was launched on Monday, August 10, 1992 as a joint US/French venture. Its mission is to map the ocean surface using radar altimetry. The measurement is so accurate that even at an altitude of 1336 km

(830 mi), it can detect height changes in the ocean surface as small as 5.0 cm. Two primary precision orbit determination (POD) systems are used -- laser and doppler shift (French Doris System). Both are limited in coverage because they are land based. A third method for POD utilizes an experimental global positioning system (GPS) receiver and offers the potential for higher accuracy.

In order to take full advantage of the science information obtainable and to provide it with a high integrity for science data processing, a program was implemented by SPAT Telecom Operations to perform End-to-End Information Systems (EEIS) monitoring. The program takes full advantage of the data structures and protocols used during data transfer - i.e. TOPEX to White Sands (WSGT) via TDRS and WSGT to JPL Project Operations Control Center (POCC) via NASCOM; and, provides Telecom Ops with an end-to-end view of data recovery.

2. EEIS MONITORING CONCEPT

The end-to-end telemetry and science recovery monitoring is inherent in/and an offshoot of the telemetry data structure used on TOPEX and the NASCOM block packaging and design. On TOPEX, the science and telemetry data is packaged in minor frames (MMS data structure -- this predates CCSDS standards for telemetry packaging). All engineering and science telemetry minor frame data is packaged with a 16 bit CRC control word (See Figure 2.1) and convolutionally encoded ($R=1/2, K=7$). The C.E. data modulates (QPSK) a carrier and is transmitted to White Sands (WSGT) via TDRSS. On the Q-Channel (recorder playback mode) the C.E. data is also interleaved prior to modulation. At WSGT, demodulation and Viterbi decoding utilizing soft detection occurs. The Q-Channel C.E. data is also de-interleaved prior to decoding. The recovered minor frame data plus frame error

control word is packaged in NASCOM blocks (-4.5 minor frames per block) with a 22 bit poly error check and is transmitted to JPL. At JPL's TOPEX/Poseidon Project Operations Control Center (POCC), the NASCOM Front End Processor (NFEP) receives the NASCOM block, deblocks the minor frames and generates the minor frame and NASCOM block CRC flags. All minor frames from an error detected NASCOM block are tagged with an NASCOM block error flag. The TOPEX data transmission/recovery scheme is depicted in Figure 2.2.

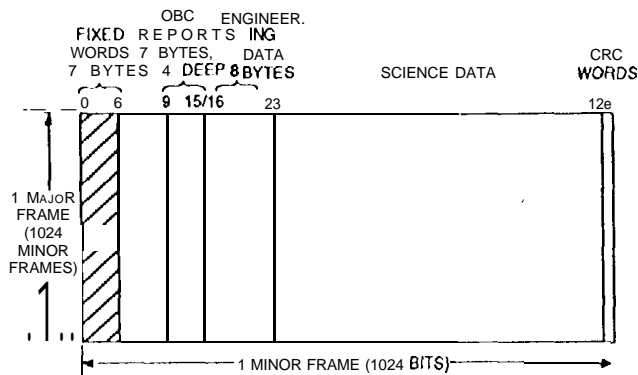

Figure 2.1. TOPEX Telemetry Stream-Major Frame Structure

By processing the received spacecraft minor frame ground generated CRC flags and the minor frame NASCOM block poly error flags (See Figure 2.2), the following can be determined:

- 1) Actual TOPEX-to-WSGT via TDRS return link BER performance -- used for link calibration, margin determination, and assessment/impact of non link budget (non RF) losses
- 2) NASCOM link BER performance - used for link assessment, fault/anomaly detection and isolation, and link management

; and, performed

- 3) End-to-End Systems (EES) monitoring
- 4) Tape recorder characterization
- 5) Science recovery assessment

3.0 MINOR FRAME ERROR FLAG PROCESSING: BER DETERMINATION

End-to-End Telemetry and Science Data Recovery Monitoring (and therefore EES monitoring) involves the calculation of a metric for assessing data recovery performance. Two metrics are available. One is the percentage of

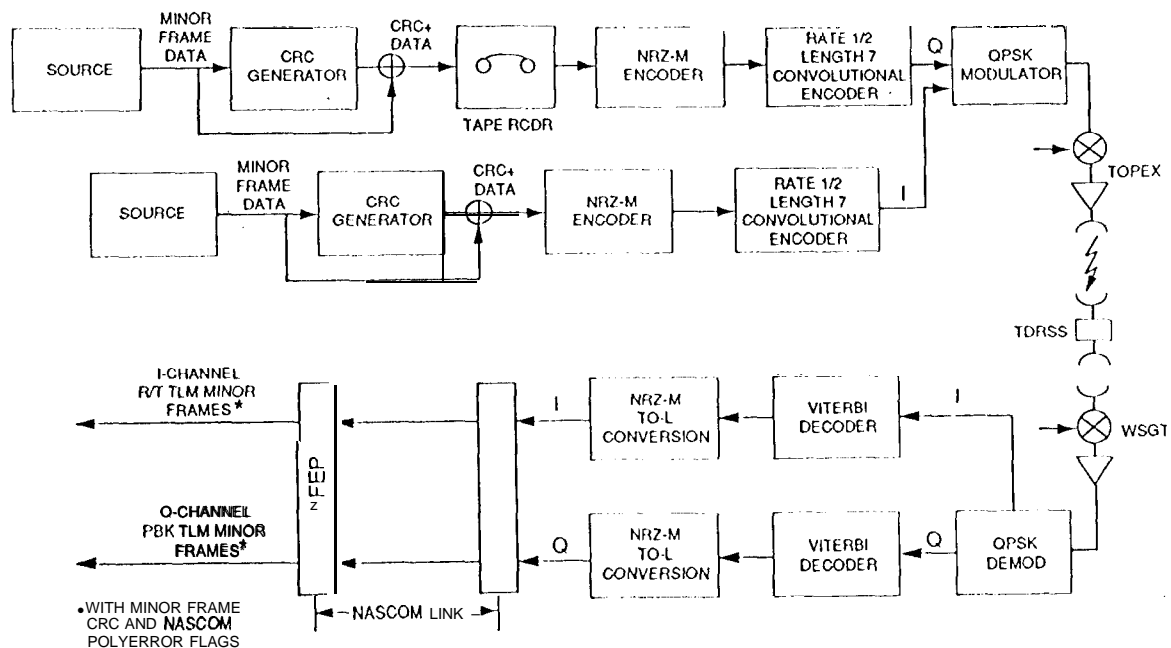

Figure 2.2. TOPEX Data Transmission/Recovery Scheme¹

¹RECOVERY SCHEME SHOWS TAPE RECORDER PLAYBACK MODE (THE Q. CHANNEL S/C INTERLEAVING AND GROUND DE-INTERLEAVING PROCESSES ARE NOT SHOWN)

data recovered and the other is the integrity of the data recovered – i.e., the BER. The calculation of the BER is based on the CRC flags.¹ The return link BER is calculated from the received minor frame files as:

$$(3.1) \text{ R/J. BER} = \frac{\text{\# of frame CRC errors}}{(\text{\# of minor frames}) (\text{Bits/Minor frame})}$$

where the bits/minor frame = 1024

The NASCOM BER is also calculated from the minor frames files as:

$$(3.2) \text{ NASCOM BER} = \frac{\text{\# of blocks with CRC error}}{(\text{\# of blocks}) (\text{bits/block})}$$

where bits/block = 4800; and,

$$\text{\# of blocks} = \frac{(\text{\# of minor frames})}{(\text{minor frames/block})}$$

The # of blocks with CRC errors (estimate) is given as:

$$(3.3) \text{ \# of blocks with CRC error (estimate)} = \frac{(\text{\# of minor frames with block CRC flagset})}{(\text{minor frames/block})}$$

and, the minor frames/block = 4624/1024 (-4.5).

A minor frame file includes all the minor frames received during a scheduled TDRS event. TOPEX schedules TDRS events based on pass type. The pass types used on the TOPEX Project are given in Table 3.0. Three types of minor frame files are processed – the 16 kbps R/T files, the MRO files, and the PBK (512 kbps) frame files. The MRO (Memory ReadOut) data from the On Board Computer (OBC) is not packaged with the S/C generated 16 bit CRC control word.

For the determination of # of minor frames, # of frame CRC errors, and # of minor frames with block CRC flagset used in equations 3.1, 3.2 and 3.3, an integration time of 2 minutes is used. The results of equation 3.1 are labeled as RLPBKBER -- for the Q-Channel PBK_SA data and RLR16BER – for the 16 kbps 1 or

Q-Channel R/T Telemetry (TLM) data. The results of equation 3.2 are labeled NSRPBKBER -- for the PBK_SA Q-Channel data returned to JPL via NASCOM links and NSR16BER – for the 16 kbps R/T Telemetry return to JPL via the NASCOM links.

Table 3.0 TOPEX Return Link Events (Pass Types)

Pass	Type	Channel/Data Rate	OPS Mode
LOAD_MRO_SA	I-Channel/16 kbps Telemetry	Q-Channel/32 kbps OBCData*	R/T Eng. TLM Memory Readout
LOAD_MRO_MA	IBID		IBID
MONITOR_MA	Q-Channel/16 kbps Telemetry	I-Channel/16 kbps Telemetry	R/T Eng. TLM Not Returned to JPL
PBK_SA	Q-Channel/512 kbps	I-Channel/16 kbps Telemetry	Recorded Science and Eng. Data R/T Frog, TLM

*Not packaged with the S/C generated 16 bit CRC control word.

4.0 APPLICATION: END-TO-END LINK MONITORING

Typical LOAD_MRO_SA 1-Channel 16 kbps performance is given in Figure 4.1. The LOAD_MRO_SA pass was scheduled via TDRS East on day 1994-187 from 20:35:00 to 21:15:00. The NASCOM BER shows no NASCOM hits and the return link 16 kbps 1-Channel shows BER performance of 2.64 x 10⁻⁸. Errors occur at the start of the pass. This is typical. Occasionally, the RF link shows error free performance; and, the performance is not TDRS dependent -- i.e. East or West.

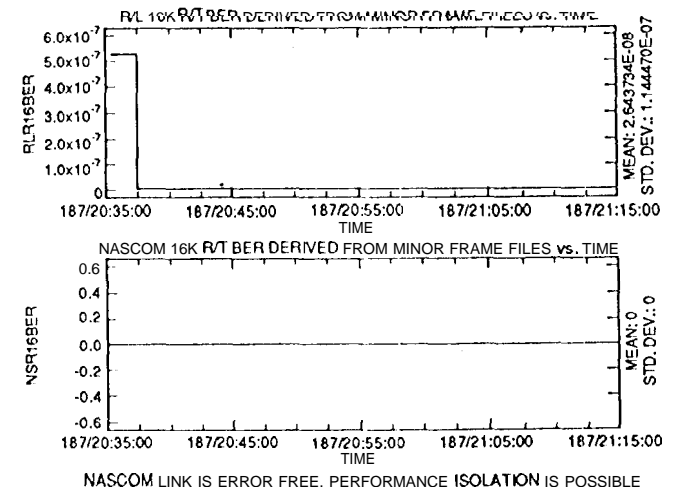

Figure 4.1. Typical LOAD_MRO_SA Performance (Day 1994-187)

A MONITOR_MA pass, Q-Channel 16 kbps return is given in Figure 4.2. This pass occurred on clay 1993-191 from 00:17:00 to 00:57:00. This pass shows random RF bit hits (not NASCOM induced). The BER performance was -5.2×10^{-8} .

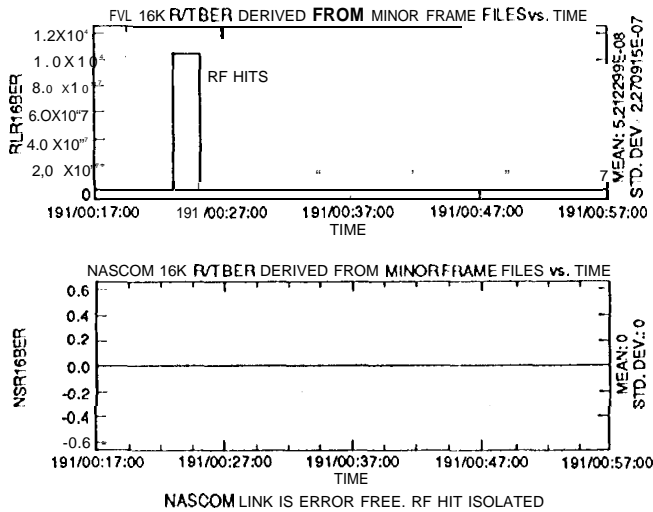

Figure 4.2. MONITOR_MA Pass (1993-191) Showing RF Bit Errors

A PBK_SA pass showing NASCOM bit errors coupling on to the received minor frame data is given in Figure 4.3. This pass occurred on day 1994-166 and was scheduled from 18:09:00 to 18:34:00 via TDRS_East. The pass was scheduled for playback of tape recorder B.

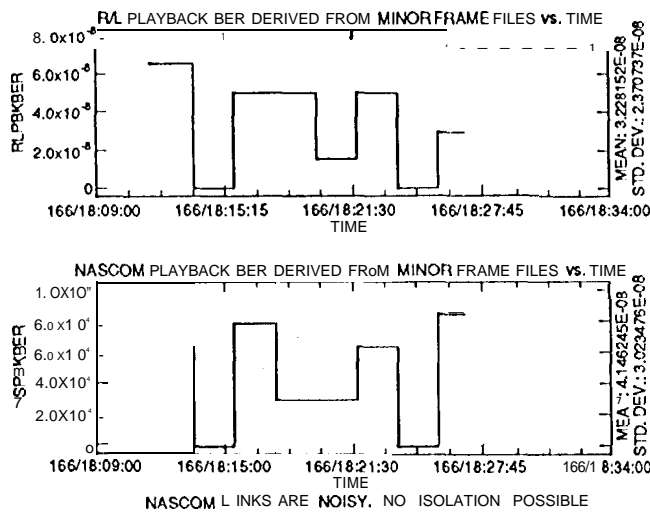

Figure 4.3. NASCOM Link Errors Coupling Onto the Received Playback Minor Frames (Tape Recorder B Playback)

Tape recorder playback characteristics and science recovery performance is given in sections 4.1 and 4.4, respectively. Playback rate is at S 12 kbps and takes -15 minutes (8 hours worth of recorded data).

The technique clearly isolates errors to the NASCOM links -- fault/anomaly detection and isolation.

4.1 APPLICATION: TAPE RECORDER PERFORMANCE CHARACTERIZATION

TOPEX/Poseidon operates with three tape recorders. These are designated as A, B, and C. Each records science and engineering data for -eight hours a day. Three PBK_SA passes are scheduled daily for TOPEX to WSGT via TDRS playback, and subsequent transmission to the JPL POCC via the NASCOM links. Tape recording begins at the beginning of tape (BOT) and playback is reversed, bringing the tape back to BOT for subsequent recording.

Because of the tape recording and playback operations; and, due the fact that the S/C generated minor frame data (including the 16 bit CRC word) are recorded, the tape recorders can be characterized and tape media errors can be isolated. Figure 4.4 shows typical tape recorder (T/R) -- C performance. This T/R-C playback occurred on day 1994-185 during a PBK_SA pass scheduled from 02:13:00 to 02:38:00. Errors and/or data gaps occur in the tape "soft spot" on -98% of the playbacks. On occasion (-2%) T/R-C displays error free

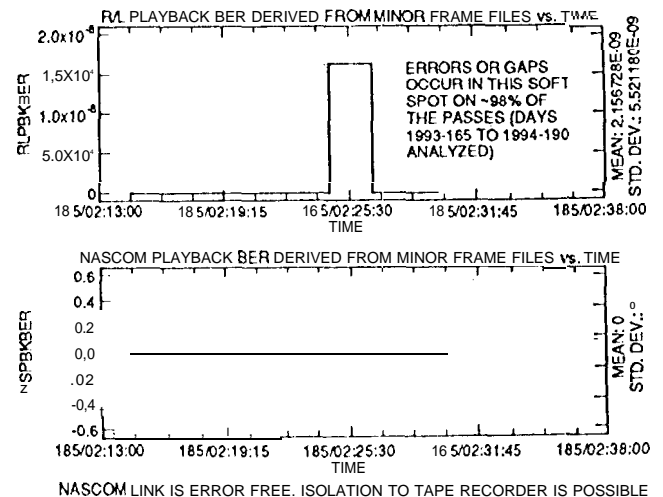

Figure 4.4. Tape Recorder C BER Signature

performance, On -39% of the passes, T/R-C shows errors in this region (T/R-C soft spot). On the other -59% of the passes, minor frame data gaps occur (4 to 8 minor frames).

Figure 4.4 is known as the T/R-C BER signature, Tape recorder-A's BER signature is given in Figure 4.5. Tape recorder-A has one soft spot and errors occur in that region on ~3% of the passes. Tape recorder-11 has four soft spots - designated as 1, 2, 3, and 4. Errors occur as follows in those regions:

- 1- 61% of the passes
- 2 - 2.9% of the passes
- 3 - 59% of the passes
- 4- 56% of the passes

For regions 1, 3, and 4 data gaps occur -39%, 41%, and 44% of the passes, respectively. The data gaps range from 4 to 8 minor frames. Tape Recorder B has multiple BER signatures, one is presented in Figure 4.6.

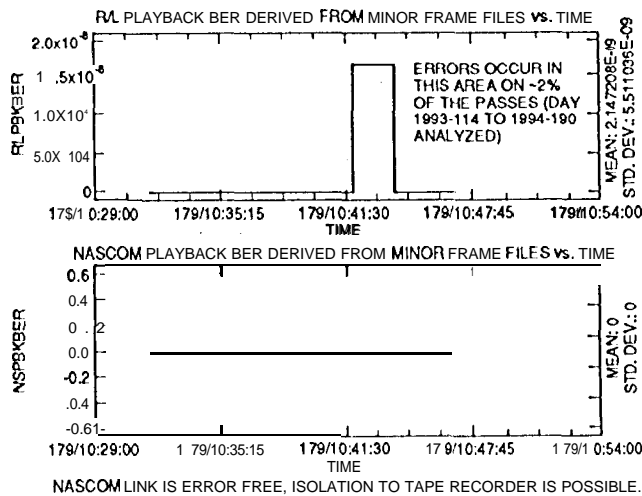

Figure 4.5. Tape Recorder A BER Signature

The overall tape recorder performance based on the PBK_SA return link (R/L) BER is given in Table 4.1. The data was taken from 1993-081 to 1993-339.

Table 4.1 Tape Recorder Performance Based on PBK_SA R/L BER

Tape Rcdr	Days 081 to 113	Days 114 to 164	Days 165 to 248	Days 249 to 339
A	1.2X 10 ⁻¹⁰	1.9 x 10 ⁻¹⁰	1.55 x 10 ⁻¹⁰	2.5 x 10 ⁻¹⁰
c	6.45 x 10 ⁻⁹	1.16 x 10 ⁻⁹	1.24 x 10 ⁻⁹	1.0 X10 ⁻⁹
B	7.16x 10 ⁻⁹	6.27 x 10 ⁻⁹	6.32 x 10 ⁻⁹	5.83 x 10 ⁻⁹

Tape recorder performance has remained stable (shown no degradation).

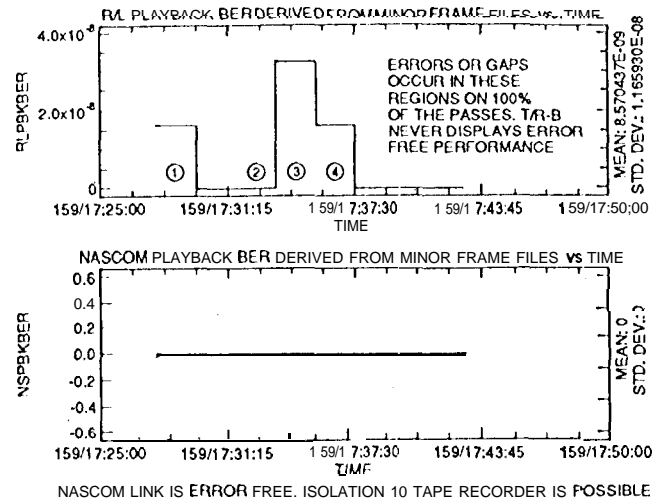

Figure 4.6. One of Many Tape Recorder B Signatures (All Soft Spots Are Shown)

4.2 APPLICATION : NASCOM LINK PERFORMANCE DETERMINATION

Using the NASCOM playback BER data (NSPBKBER), NASCOM link performance during the PBK_SA passes was analyzed early during TOPEX's project (1993-093 to -339). The results are summarized in Table 4.2. The NASCOM configuration being used is designated.

Table 4.2 NASCOM Return Link BER Performance (PBK_SA512 kbps Playback)

Days	NASCOM Configuration	BER	Total Passes
09310189	768 kbps	9.14 x 10 ⁻¹⁰	286
19010227	536 kbps	3.19X 10 ⁻⁸	112
228 to 248	544 kbps	5.71 x 10 ⁻¹⁰	63
249 to 339	544 kbps	2.5 x 10 ⁻⁹	266

Using the NASCOM return link BER data (NSR16BER) for the 16 kbps real time telemetry, the NASCOM link performance was determined for days 1993-179 to 234. The results are given in Table 4.3.

Table 4.3 NASCOM Return Link Performance (16 kbps Real Time Telemetry)

Passtype	Channel	BER	Total Passes
PBK_SA	I	3.47 x 10 ⁻⁹	158
LOAD_MRO_SA	I	1.69 x 10 ⁻⁹	62
LOAD_MRO_MA	I	2.93 x 10 ⁻⁹	69
MONITOR_MA	Q	4.4 x 10 ⁻⁹	624

The NASCOM links are monitored by TOPEX and NASCOM is informed of link performance. Based on this monitoring, TOPEX requested a link configuration change from 536 kbps to 544 kbps for the tape recorder playback.

4.3 APPLICATION: TOPEX TO WSGT RETURN LINK PERFORMANCE DETERMINATION

By accounting for NASCOM link performance and tape recorder performance, the actual TOPEX to WSGT via TDRS link performance was determined. Passes where NASCOM link performance could not be decoupled from the TOPEX to WSGT RF link were omitted from the analysis – but included in Section 4.2 analysis. The observed TOPEX to WSGT via TDRS performance is given in Table 4.4.

Table 4.4 TOPEX to WSGT via TDRS Return Link Performance

Passtype/Channel	BER	Margin		Passes
		Actual ¹	Expected ²	
LOAD_MRO_SA (I-Channel)	4.72×10^{-8}	1.6 dB	13.4 dB	61
LOAD_MRO_MA (I-Channel)	1.06×10^{-8}	2.0 dB	9.3 dB	65
MONITOR_MA (Q-Channel)	2.95×10^{-10}	2.7 dB	9.3 dB	572
PBK_SA				
I-Channel	8.09×10^{-8}	1.5 dB	13.4 dB	153
Q-Channel	4.53×10^{-11}	3.1 dB	5.3 dB	536

¹Based on $E_b/N_0 = 4.5$ dB for Viterbi decoding (soft detection)

²Based on link budgets

The difference in the actual and expected performance can be explained by non-RF losses – i.e. phase noise, AM/PM, synchronization losses, etc. at WSGT. Based on the formalism presented in Reference 2, WSGT appears to have a performance and error floor for I-Channel performance (PN code “on”) at -1×10^{-8} , a performance and error floor for Q-Channel performance (PN code “on”) at $\sim 1 \times 10^{-10}$; and, a performance and error floor for Q-Channel performance (PN code “off”) at $\sim 1 \times 10^{-11}$. Based on the above, during the LOAD_MRO_SA/MA and PBK_SA I-Channel 16 kbps telemetry returns, WSGT displays the performance of a marginal system (Ref. 2 formalism). During the MONITOR_MA Q-Channel return passes, WSGT displays

performance of a better than marginal system. During the PBK_SA Q-Channel 512 kbps playback, WSGT displays performance closer to a “well-equalized practical system” (Ref. 2 formalism).

4.4 APPLICATION: PLAYBACK (SCIENCE RECOVERY) PERFORMANCE

The TOPEX overall playback performance (accounting for tape recorder performance, TOPEX to WSGT via TDRS link performance and NASCOM performance) is given in Table 4.5. This is based on days 1993-081 to -339 data.

Table 4.5 TOPEX Overall Playback (Science Recovery) Performance

Link Element	BER (Average)	Comments
Tape recorders	3.0×10^{-9}	Limited by T/R-B Performance
PBK_SA Link Performance (TOPEX to WSGT via TDRS)	4.54×10^{-11}	Limited by WSGT Equipment
NASCOM Link	6.24×10^{-9}	Limited by TDMA Configuration
Overall Performance Playback	$-9 \text{ XI}(Y9)$	Limited by NASCOM Performance

4.5 APPLICATION: STGT VERSUS WSGT PERFORMANCE

The second TDRS Ground Terminal (STGT) will replace the White Sands Ground Terminal (WSGT) by the end of this year - 1994. TOPEX has performed limited tests using the STGT and TDRS_S(E). These tests included PBK_SA passes – scheduled for days 1994-045, -059, -087, and -095 and modified MON_MA (I-Channel data returned) tests -- scheduled for days 1994-043, -057, -080, -084, -089, -095, -097 and -108. STGT BER results are given in Table 4.6 and are compared to WSGT performance.

Table 4.6 STGT vs WSGT Performance

Passtype/Channel	BER Performance	
	STGT	WSGT
PBK_SA/Q	3.33×10^{-8}	4.53×10^{-11}
PBK_SA/I	1.06×10^{-7}	8.09×10^{-8}
MONITOR_MA/I	9.19×10^{-8}	1.06×10^{-8} *

* Based on LOAD_MRO_MA performance

Based on the limited STGT tests, STGT displays the performance of a marginal system (Ref. 2 formalism) with a performance and error floor at -1×10^{-8} . Playback performance (PBK_SA Q-Channel) for STGT appears to be substantially worse than WSGT's performance. The original STGT results are documented in Reference 3.

5.0 CONCLUSION

Jacques Cousteau stated⁴ that "remote sensing, backed by telemetry, is undoubtedly one of the fastest developing, as well as one of the most promising technologies of our times...". By taking advantage of spacecraft telemetry and ground data system structures and protocols, TOPEX/Poseidon has successfully implemented an end-to-end information systems (EEIS) monitoring program that allows the project scientist to take full advantage of the radar altimetry and POD data obtained.

ACKNOWLEDGEMENT

The research described in this paper was carried out by the Jet Propulsion Laboratory, California Institute of Technology, under a contract with the National Aeronautics and Space Administration.

FOOTNOTES/REFERENCES

¹BER calculation equating frame error rate to BER was presented at the "TOPEX/Poseidon Telecom Subsystem Review - Part II", July 1992, B. Calanche. Based on the expected link margins, one CRC error is equated to one bit error. This assumption falls apart for the tape recorder channel. Even then, a pseudo BER can be calculated based on equating 1 minor frame loss to a single CRC error, since the science people exclude minor frames with a CRC flag set.

²"Telecommunications Measurements, Analysis and Instrumentation", Dr. Kamilo Feher, Prentice-Hall, Englewood Cliffs, New Jersey, 1987.

³JPL Interoffice Memorandum (IOM) 3395-94-09, "Second TDRSS Ground Terminal (STGT) Tests: Telecom Performance Through Day 1994-108", April 19, 1994, B. Calanche. (Internal Memo)

⁴Excerpt from Captain Jacques Cousteau's speech, "A Time to Choose", to the Eurospace Society, Monaco, October 1975.