

Evolutionary Mechanisms for Smart On-board Adaptive Sensing applied to the MECA Electrometer¹

Didier Keymeulen, Adrian Stoica, Martin Buehler, Ricardo Zebulum and Vu Duong
Jet Propulsion Laboratory
California Institute of Technology
4800 Oak Grove Drive
Pasadena, CA 91109
818-354-4280
didier.keymeulen@jpl.nasa.gov

Abstract— In-situ exploration as required for example by missions to comets and planets with unknown environmental conditions, has recently been approached with new ideas, such as the use of biology-inspired mechanisms for hardware sensor adaptation. The application of evolution-inspired formalisms to hardware design and self-configuration lead to the concept of evolvable hardware (EHW). EHW refers to self-reconfiguration of electronic hardware by evolutionary/genetic reconfiguration mechanisms. In this paper we describe the initial development of efficient mechanisms for smart on-board adaptive sensing, adaptively controlling the reconfigurable pre-processing analog electronics using evolvable hardware, which will lead to higher quality, lean data.

TABLE OF CONTENTS

1. INTRODUCTION
2. ELECTROMETER SENSOR ARRAY
3. ADAPTIVE SENSOR ARCHITECTURE
4. EVOLUTION-ORIENTED DEVICES AND ENVIRONMENT
5. ADAPTIVE SENSORS EXPERIMENT
6. CONCLUSION

1. INTRODUCTION

High data rates provided by modern sensors surpass on-board real-time processing capabilities. This is addressed by imposing large on-board storage memory and high communications bandwidth; there is however no good solution to using the data in real-time control situations such as fast entry, descent and landing, or within sensor webs. Only a small fraction of the data carries quality information, yet current pre-processing electronics is not smart enough to eliminate useless/redundant data. In fact more information could be obtained from the sensor if the electronics would adapt to incoming signals and the context of the measurement.

The concept of reconfigurable and adaptive electronics for signal conditioning has led to a series of recent chips that allow programmable adjustment of amplifier gains, memory-based compensation of sensor nonlinearity, etc [25].

However, the flexibility of these programmable devices is limited by the high level of reconfiguration granularity, and require that all compensation data is predetermined through lab experiments and then stored in ROM; also no later changes in sensor characteristics or electronics itself could be considered once the sensor is in operation.

A complementary technique, called evolvable hardware (EHW), allows the automatic determination of optimal electronic circuit configurations. In particular a chip designed for evolvable hardware experiments, the Jet Propulsion Laboratory (JPL) Field Programmable Transistor Array (FPTA) has high flexibility by reconfiguration at transistor level [28]. Evolutionary algorithms allow for automatic determination of optimal configuration. In the narrow sense EHW refers to self-reconfiguration of electronic hardware by evolutionary/genetic reconfiguration mechanisms as in our application. In a broader sense EHW refers to various forms of hardware, from antennas to complete evolvable space systems that could adapt to changing experimental environments and, moreover, increase their performance during the mission.

In this paper we describe the initial development of efficient mechanisms for smart on-board adaptive sensing, adaptively controlling the reconfigurable pre-processing analog electronics using evolvable hardware, which will lead to higher quality, lean data. The target is to demonstrate the mechanisms on an adaptive electrometer providing the same or more information content than the MARS'01 MECA (Mars Environmental Compatibility Assessment) Electrometer with a significant reduction in the total amount of transmitted data. The electrometer was part of MECA project and has as objective of the project to gain a better understanding of the hazards related to the human exploration of Mars.

In the paper we identify one application of adaptive sensor array device for which the reduction of the data can be considerable: discrimination task of materials with different triboelectric properties. The discrimination task requires a sophisticated analysis of the multiple responses in order to extract differences in signal as well as an adaptation

¹ 0-7803-6599-2/01/\$10.00 © 2001 IEEE

mechanism to deal with the high sensitivity of the sensor array to ambient conditions. The analysis and sensitivity are translated to requirements and fitness evaluation metrics that are used by an evolutionary algorithm to determine the optimal adaptation mechanisms.

This paper reports on experiments that illustrate how evolutionary algorithms can design analog circuit integrated in the sensing elements and adapted to the experimental conditions. The search for an electronic circuit realization of a desired transfer characteristic can be made in software as in *extrinsic* evolution, or in hardware as in *intrinsic* evolution. In *extrinsic* evolution, the final solution is downloaded to (or becomes a blueprint for) the hardware. In *intrinsic* evolution the hardware actively participates in the circuit evolutionary process and is the support on which candidate solutions are evaluated. In this paper we will only look at the extrinsic approach.

This paper is organized as follows: Section 2 presents a description of the electrometer sensor array. Section 3 presents the adaptive sensor architecture. Section 4 presents an evolution-oriented architecture for reconfigurable hardware based on the concept of FPTA and the details of the evolutionary design tool. Section 5 presents the experiments and results obtained for the adaptive electrometer for a discrimination application in a changing environment. Section 7 presents some lessons learned from the experiments and section 8 concludes the paper.

2. ELECTROMETER SENSOR ARRAY

The electrometer is part of MECA project. The objective was to gain a better understanding of the hazards related to the human exploration of Mars. The MECA project also has a material patch experiment to determine the effects of dust adhesion, a wet chemistry laboratory with ion selective electrodes to characterize the ionic content of the soil, and microscopy station with optical and atomic force microscopes to determine particle size and hardness.

The electrometer was built into the heel of the Mars '01 robot arm scoop as seen in Fig. 1. The instrument has four sensor types: (a) triboelectric field, (b) electric-field, (c) ion current, (d) temperature. The triboelectric field sensor array contains five insulating materials to determine material charging effects as the scoop is dragged through the Martian regolith. The insulating materials were chosen after Earth-based tests in Mars simulant soils.

During digging operation the electrometer is out of the way. After digging, the scoop is rotated so the electrometer head is pointing down toward the Martian soils allowing it to be rubbed against the Martian soil.

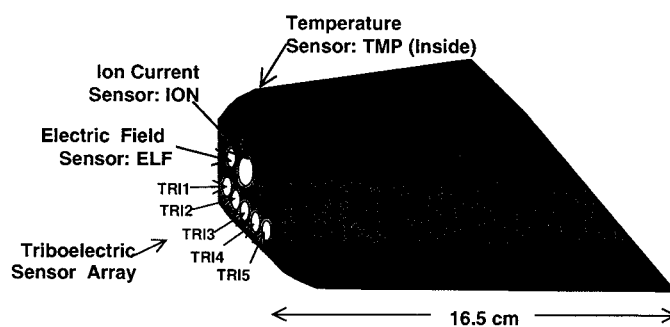

Figure 1. Electrometer sensor suite mounted in the heel of the Mars'01 scoop

In the rubbing sequence, depicted in Fig. 2, the scoop is first lowered against the Martian soil. During the start of the traverse, the electrometer is zeroed by closing a switch which will be discussed later. After reaching the end of its traverse, the scoop is abruptly removed from the soil at which time the triboelectric sensor response is measured.

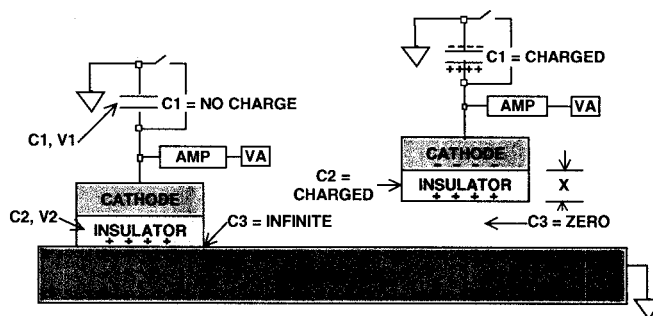

Figure 2. Operational scenario for the scoop and charge distribution in the electrometer during rubbing (left) and after removal from the surface (right).

As seen on the left in Fig. 2, charge is generated triboelectrically across capacitor C3 as the insulator is rubbed on the Martian surface. Since the charges are in close proximity across C3, no charge appears across capacitors C1 or C2. As the insulator is removed from the surface, the charges redistribute themselves across C1 and C2 according to the charge relationship $Q1 = Q2$ and provide the signal for the amplifier.

This electrometer is an induction field meter [19] operated in a direct current mode, where the operational amplifier input current charges C1. The electrical schematic of the non-adaptive component of the triboelectric sensors is shown in Fig. 3. The design of the electric field sensor follows from the traditional electrometer [20]. The instrument is composed of a capacitive divider where C2 is the field sensing capacitor and C1 is the reference capacitor. The point between the capacitors is connected to the positive terminal of the first stage amplifier (terminal +5 of U3) operated in the follower mode. The sensing electrode is protected by a driven guard that is connected to the negative terminal of the first stage amplifier (terminal -6 of U3). A second operational amplifier (U4) is added to provide

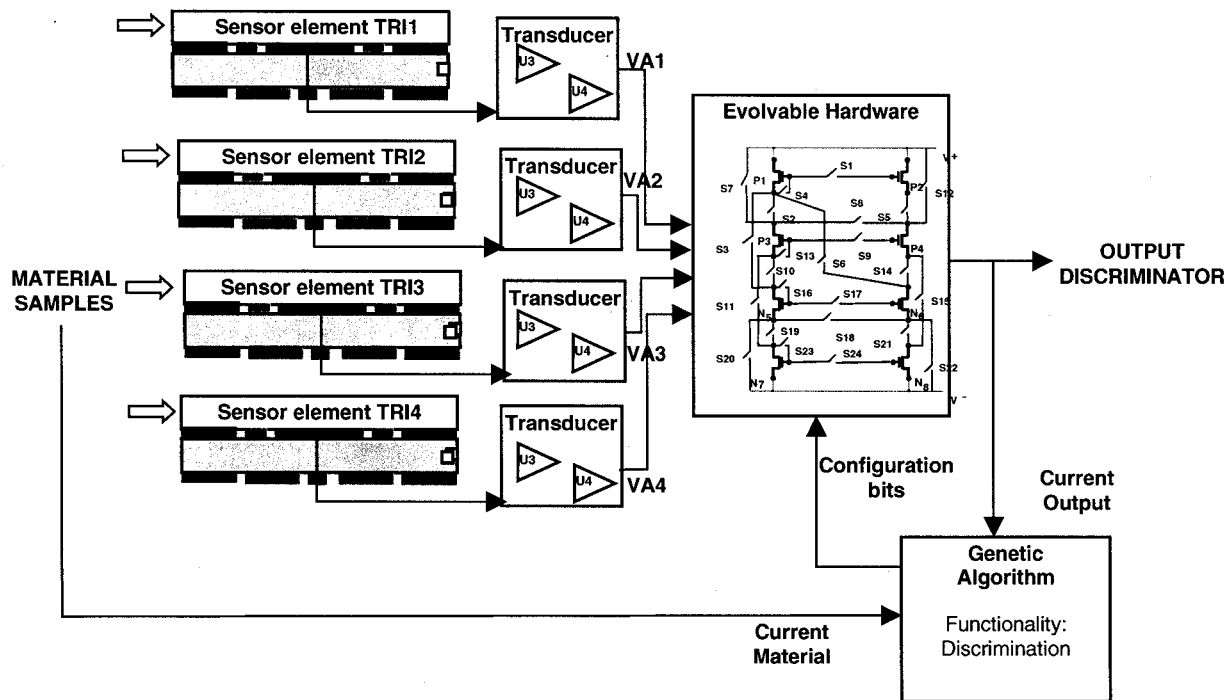

Figure 5. Schematic arrangement of an adaptive electrometer sensor array device

4. EVOLUTION-ORIENTED DEVICES AND ENVIRONMENT

The idea of a FPTA was introduced first by Stoica in [11]. The FPTA is a concept design for hardware reconfigurable at the transistor level. As both analog and digital CMOS circuits ultimately rely on functions implemented with transistors, the FPTA is a versatile platform for the synthesis of both analog and digital (and mixed-signal) circuits. Further, it is considered a more suitable platform for synthesis of analog circuitry than existing FPGAs or FPAAs, extending the work on evolving simulated circuits to evolving analog circuits directly on the chip.

The FPTA module is an array of transistors interconnected by programmable switches. The status of the switches (ON or OFF) determines a circuit topology and consequently a specific response. Thus, the topology can be considered as a function of switch states, and can be represented by a binary sequence, such as "1011...", where a 1 represents an ON switch and a 0 represents a OFF switch. The FPTA architecture allows the implementation of bigger circuits by cascading FPTA modules with external wires. To offer sufficient flexibility the module has all transistor terminals connected via switches to external terminals (except for power and ground). Issues related to chip expandability were treated in elsewhere [11]. Figure 6 illustrates an example of a FPTA module consisting of 8 transistors and 24 programmable switches. In this example the transistors P1-P4 are PMOS and N5-N8 are NMOS, and the switch-based

connections are in sufficient number to allow a majority of meaningful topologies for the given transistor arrangement, and yet less than the total number of possible connections. Programming the ON and OFF switches defines a circuit. The effects of non-zero, finite impedance of the switches can be neglected in the first approximation. One FPTA module was fabricated as a Tiny Chip through MOSIS, using 0.5- μm CMOS technology. We build a testbed for future development with a test board with four chips mounted on it and connected with the electrometer (Fig. 7).

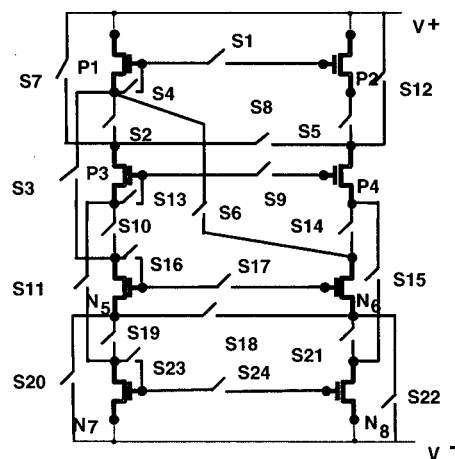

Figure 6. Module of the Programmable Transistor Array

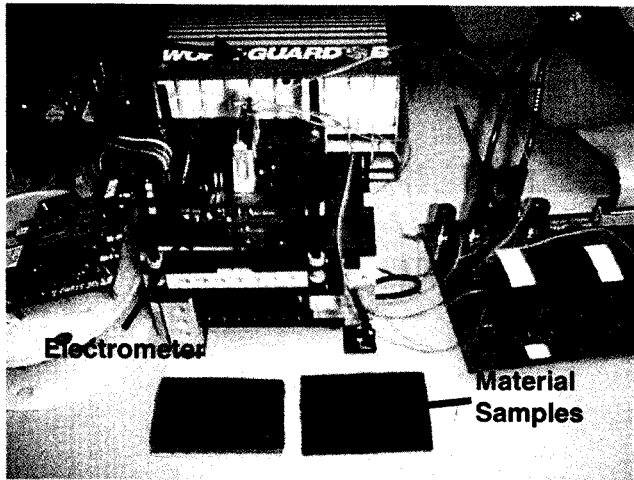

Figure 7. Module of the Programmable Transistor Array connected to the electrometer.

In the context of electronic synthesis on reconfigurable devices such as the FPTA, the architectural configurations are encoded in "chromosomes" that define the state of the switches connecting elements in the reconfigurable hardware. The main steps in evolutionary synthesis of electronic circuits are illustrated in Figure 8. First, a population of chromosomes is randomly generated to represent a pool of circuit architectures. The chromosomes are converted into control bit strings, which are downloaded onto the programmable hardware. In the particular case of the FPTA cell, the chromosome has 24 bits that determines the state of the 24 switches (Figure 6). Circuit responses are compared against specifications of a target response using as fitness the root mean square error. The individuals are ranked based on their fitness; that is, how close they come to satisfying the target. Preparation for a new iteration loop involves generation of a new population of chromosomes from the pool of the best individuals in the previous generation. Individuals are selected probabilistically based on their fitness. Some are taken as they were and some are modified by genetic operators, such as chromosome crossover and mutation. The process is repeated for a number of generations, resulting in individuals with increasingly better fitness. The genetic algorithm is usually ended after a given number of generations, or when the closeness to the target response has been reached. In practice, one or several solutions may be found among the individuals of the last generation.

In addition to the procedure described above, which is called *intrinsic Evolvable Hardware* or *hardware evolution*, Figure 8 also shows an alternative way to carry on evolutionary circuit synthesis, by the use of simulators instead of reconfigurable chips. In this particular case, the chromosome is mapped into a SPICE circuit model, which is simulated and evaluated. This later procedure is called *extrinsic Evolvable Hardware* or *software evolution*. The mapping of the chromosome into the circuit netlist is accomplished by examining the chromosome values bit by bit. According to each bit value (0 or 1), the state of its

corresponding switch will be set in the circuit netlist. After all the switches' states are determined, the circuit is simulated. The extrinsic approach has been used for the experiments of the adaptive electrometer sensor array. The intrinsic approach is currently under development.

An evolutionary design tool EHWPack (Figure 8) was developed to facilitate experiments in hardware and software evolution [10], as defined in the previous section. This tool incorporates the public domain Parallel Genetic Algorithm package PGAPack as genetic engine running on a UNIX workstation. Referring to software evolution, we incorporated in the EHWPack, the SPICE 3F5 as circuit simulator. In the case of hardware evolution, the tool proved very useful in testing architectures of reconfigurable hardware and demonstrating evolution on FPTA reconfigurable chips. An interface code links the GA with the hardware where potential designs are evaluated, while a Graphical User Interface (GUI) allows easy problem formulation and visualization of results. At each generation the GA produces a new population of binary chromosomes, which get converted into configuration bits downloaded into the 4 FPTAs reconfigurable chips or into *Netlists* that describe candidate circuit designs, and are further simulated by SPICE.

A variety of circuits have been synthesized through evolutionary means. For example, Koza used Genetic Programming (GP) to grow an "embryonic" circuit to one that satisfies desired requirements [1]. This approach was used for evolving a variety of circuits, including filters and computational circuits. An alternative encoding technique for analog circuit synthesis, which has the advantage of reduced computational load was used in [2] for automated filter design. On-chip evolution was demonstrated by Thompson [3] using an FPGA as the programmable device, and a Genetic Algorithm (GA) as the evolutionary mechanism. More details on current work in evolvable hardware are found in [4], [5], [6], [7]. Current programmable analog devices are very limited in capabilities and do not support the implementation of the resulted design (In principle, one can test their validity in circuits built from discrete components, or in an ASIC). More recently, evolutionary experiments were performed on COTS FPAAs [18] and an ASIC [11].

20% population size. The fitness function seeks to maximize the voltage difference at the output when different materials are used for rubbing. It can be described by the following equation:

$$Fitness = \frac{1}{T} \int \sum_{i \neq j} |V_i(t) - V_j(t)|$$

where the indexes i and j sweep the four patterns of the three materials and the baseline and T is the period of time used to evaluate the fitness.

The main task of evolution is to synthesize a circuit able to discriminate among the three materials and the baseline by amplifying the voltage differences among the materials measured by the sensors. Figure 12 depicts the evolved circuit:

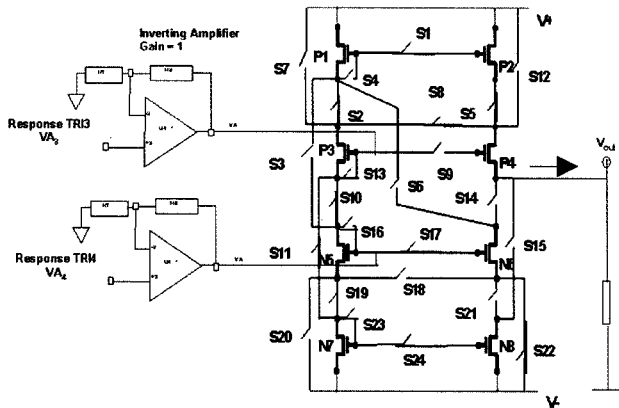

Figure 12. Evolved circuit able to discriminate among 3 materials and 1 baseline.

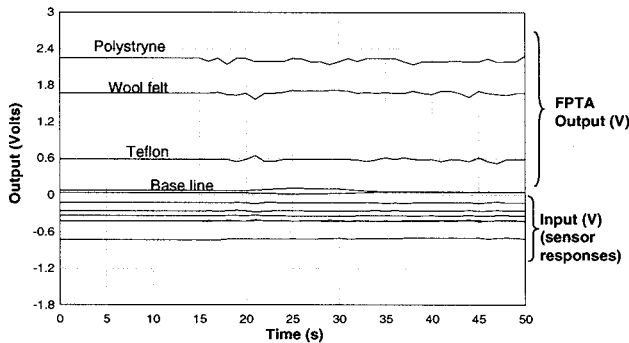

Figure 13. Response of the evolved circuit for 3 materials and 1 baseline. The time starts when the material sample is rubbed on the isolating materials of the electrometer.

Figure 13 shows the response of the evolved circuit. In the negative part of the graph are the responses of the electrometer to the 3 materials and the baselines. Before being applied to the FPTA, they pass through a unit gain inverter stage (Fig. 12). In the positive part of the vertical axis the circuit response for the four patterns is shown. There is an average separation of 0.6V between the adjacent materials, except for the wool felt and teflon materials, for

which the difference is 1.2V. The overall output range achieved a value around 2.3V, whereas the input range given by the responses of the sensor is around 0.7V. Thus the circuit improved the discrimination margin for different materials.

To assess the generalisation of the circuit solution we have tested the evolved circuit with sensor responses with slightly different environmental conditions which resulted in a decrease in the response of the sensors. As expected, the difference in response of the evolved circuit was smaller but it still captured the correct order of the patterns corresponding to the triboelectric series [26,27] (Figure 14).

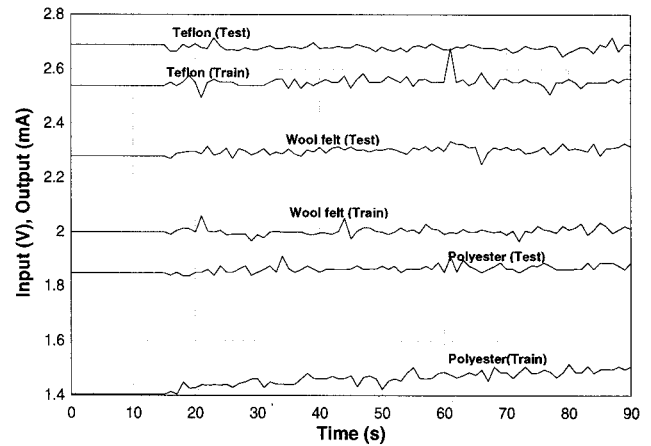

Figure 14. Response of the evolved circuit for 3 materials for slightly different environmental conditions than for experiment of Figure 13. The output measures the output current I_{out} at the drain of transistor P4.

Second Experiment: Adaptation to Environmental Conditions

The second evolutionary experiment was conducted in air at 970mb, relative humidity of 33 percent and 21C but the ambient atmosphere was artificially ionized using an air ionizer having an effect to rapidly discharge the insulators of the electrometer.

The evolvable hardware used one FPTA cell. The circuit had two inputs and one output. At the two inputs, we injected the sensor responses of the insulating material TRI3 (Teflon, response C3) and TRI4 (Rulon-J, response C4) to the three rubbing materials in addition to the baseline as shown in Fig.15, 16 and 17.

perform voltage to current conversion and to increase the discrimination margin of the system by providing gain. The current mirror gain provides an additional increase of the discrimination margin. As the sensors' signals are not constant in time in this case, an integrator is necessary to give the final answer of the system. Figure 19 shows the current mirror output (voltage at the drain of the second transistor of the pair) for the three materials and base line. After being integrated, the final response is displayed in Figure 20.

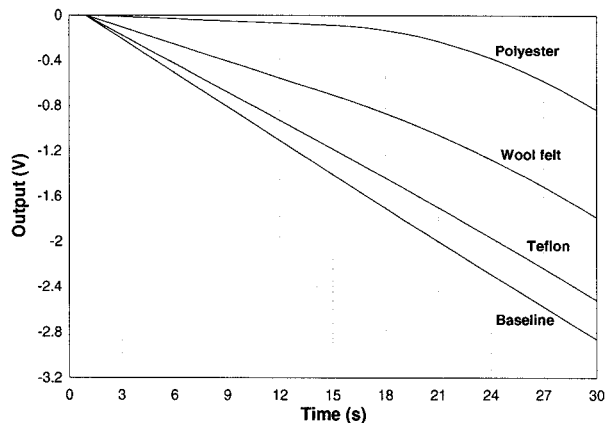

Figure 20. Response of the evolved circuit for 3 materials and 1 baseline in new environmental condition after integration. The output measures the voltage V_{out} at the output of integrator

From Figure 20 it can be seen that at 30 seconds, the integrator output reaches around $-0.8V$ for the polyester material, $-1.7V$ for the wool felt material, $-2.5V$ for the teflon material and $-2.9V$ for the base line. Thus the evolved circuit improved the discrimination margin for different materials. Moreover it kept the correct order of the patterns corresponding to the triboelectric series [26,27].

6. CONCLUSION

These initial experiments, while illustrating the power of evolutionary algorithms to design analog circuit for sophisticated analysis of responses of sensor array and to maintain functionality by adapting to changing environments, only prepare the ground for further questions. Examples of further questions include addressing how the evolutionary mechanism can be implemented in hardware such that it can be integrated in the sensor, or how should the sensors responses be stored to avoid repeating the experiments for evaluating each circuit configuration.

The long term results of the proposed research would allow sensor electronics to adapt to incoming data and extract higher quality data, making available information otherwise not accessible. It will make sensor systems adaptive and intelligent. It will increase the amount of information

available from sensors, while actually decreasing the amount of data needed for downlink.

ACKNOWLEDGMENT

The research described in this paper was performed at the Center for Integrated Space Microsystems, Jet Propulsion Laboratory, California Institute of Technology and was sponsored by the Defense Advanced Research Projects Agency (DARPA) under the Adaptive Computing Systems Program and the National Aeronautics and Space Administration.

REFERENCES

- [1] J. Koza, F.H. Bennett, D. Andre, and M.A. Keane, "Automated WYWIWYG design of both the topology and component values of analog electrical circuits using genetic programming", *Proceedings of Genetic Programming Conference*, Stanford, CA, pp. 28-31, 1996
- [2] J. Lohn, J. and S. Colombano, "Automated Analog Circuit Synthesis using a linear representation", M. Sipper, D. Mange and A. Perez-Urbe (Eds.) *Evolvable Systems: From Biology to Hardware*, Springer-Verlag Lecture Notes in Computer Science Berlin 1998, pp. 125-133
- [3] A. Thompson, "An evolved circuit, intrinsic in silicon, entwined in physics". In *International Conference on Evolvable Systems*. Springer-Verlag Lecture Notes in Computer Science, 1996, pp. 390-405.
- [4] E. Sanchez and M. Tomassini (Eds.) *Towards Evolvable Hardware*, LNCS 1062, Springer-Verlag, 1996
- [5] T. Higuchi, M. Iwata, and W. Liu (Eds.) *Evolvable Systems: From Biology To Hardware*, *Proc. of the First International Conference, ICES 96*, Tsukuba, Japan, Springer-Verlag Lecture Notes in Computer Science, 1997.
- [6] M. Sipper, D. Mange, A. Perez-Urbe (Eds.) *Evolvable Systems: From Biology To Hardware*, *Proc. of the Second International Conference, ICES 98*, Lausanne, Switzerland, Springer-Verlag Lecture Notes in Computer Science, 1998.
- [7] J. R. Koza, F. H. Bennett III., D. Andre and M. A. Keane, *Genetic Programming III - Darwinian Invention and Problem Solving*, Morgan Kaufman, San Francisco, 1999
- [8] E. Vitoz, *Analog VLSI Processing: Why, Where and How*, *Journal of VLSI Processing*, Kluwer, 1993
- [9] Stoica, A. On hardware evolvability and levels of granularity. *Proc. of the International Conference "Intelligent Systems and Semiotics 97: A Learning Perspective*, NIST, Gaithersburg, MD, Sept. 22-25, 1997
- [10] Stoica, A. Klimeck, G. Salazar-Lazaro, C. Keymeulen, D. and Thakoor, A. Evolutionary design of electronic devices and circuits, *Proc. of the 1999 Congress on Evolutionary Computation*, Washington, DC, July 6-9, 1999
- [11] Stoica, A. Toward evolvable hardware chips: experiments with a programmable transistor array. *Proceedings of 7th International Conference on Microelectronics for Neural, Fuzzy*

and *Bio-Inspired Systems*, Granada, Spain, April 7-9, IEEE Comp Sci. Press, 1999.

[12] Layzell, P. "A New Research tool for Intrinsic Hardware Evolution", *ICES'98*, Lausanne, Switzerland, 1998

[13] P. Marchal et al. Embryological development on silicon. In R. Brooks and P. Maes, editors, *Artificial Life IV*, pages 365-366. MIT Press, 1994.

[14] White R. and Miles F. Principles of Fault Tolerance. In *Proceedings of Eleventh Annual Applied Power electronic Conference and Exposition*, pages 18-25, Vol.1. IEEE Press, 1996.

[15] Thompson A. In *Proceeding of the First International Conference on Genetic Algorithms in Engineering Systems: Innovations and Applications*, page 524-529. IEEE Press, 1995.

[16] Layzell, P. In *Proceedings of the First NASA/DoD Workshop on Evolvable Hardware*, pages 85-86. IEEE Computer Society Press, 1999.

[17] Stoica A., Keymeulen D., Tawel R., Salazar-Lazaro C., Li W. In *Proceedings of the First NASA/DoD Workshop on Evolvable Hardware*, pages 76-84. IEEE Computer Society Press, 1999.

[18] Zebulum, R. et al., "Analog Circuits Evolution in Extrinsic and Intrinsic Modes" In *Proc. of the Second International Conference, ICES 98*, Lausanne, Switzerland, Springer-Verlag Lecture Notes in Computer Science, 1998, pp 154-165.

[19] J. A. Cross, *Electrostatics: Principles, Problems and Applications*, Adam Hilger (Bristol, UK).

[20] "Electrometer Measurements", Keithley Instruments (Cleveland OH), 1972

[21] Julian W. Gardner, *Microsensors: Principles and Applications*. New York: John Wiley & Sons, 1994.

[22] Gert van der Horn and Johan L. Huijsing, *Integrated Smart Sensors: Design and Calibration*. New York: Kluwer Academic Publishers, 1998.

[23] M. Buehler, *Rocking Mineral Experiments*, Internal Technical Report, JPL. 16 January 2000. Pasadena, CA.

[24] M. Buehler et al., MECA Electrometer: Initial Calibration Experiments. In *Proceedings of the 10th International Conference (Electrostatics 1999)*. Institute of physics Conference Series No 163, pp 189-196, Institute of Physics Publishing, Bristol, UK, 1999.

[25] B. Schweber, Programmable analog Ics: designer's delight or dilemma ?. In *EDN*. April 2000. Cahners Publication.

[26] O.J. McAteer, *Electrostatic Discharge Control*. McGraw-Hill, 1989.

[27] N. Jonassen, *Electrostatics*, Chapman & Hall, 1998.

[28] A. Stoica et al.. Reconfigurable VLSI Architectures for Evolvable Hardware: from Experimental Field Programmable Transistor Arrays to Evolution-Oriented Chips. In *IEEE Transactions on VLSI*. April 2001, IEEE Press.

Didier Keymeulen is a Research Engineer at the Jet Propulsion Laboratory of the California Institute of Technolog.. His interests are in complex dynamical systems applied to the design of adaptive embedded systems. He obtained his M.Sc. and Ph.D. in Computer Science from the Artificial Intelligence Laboratory of the Vrije Universiteit Brussel, Belgium.

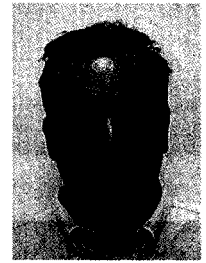

Adrian Stoica is a Senior Member of Technical Staff at Jet Propulsion Laboratory, California Institute of Technology, Pasadena, CA. His research interests include learning and adaptive hardware, evolvable hardware, sensor fusion processors, robot learning, and humanoid robots. He has published more than 50 papers in these areas. He has a Ph.D. in EE from Victoria University of Technology, Melbourne, Australia, and a MSEE from Technical University of Iasi, Romania.



Martin Buehler is a Senior Research Scientist at the Jet Propulsion Laboratory of the California Institute of Technology. He received the BSEE and MSEE from Duke University in 1961 and 1963, respectively and the Ph.D. in EE from Stanford University in 1966 specializing in Solid State Electronics. He worked at Texas Instruments for six years, at National Bureau of Standards (now NIST) for eight years. At JPL he has developed p-FET radiation monitors for CRRES, Clementine, TELSTAR and STRV, E-nose which flew on STS-95, and an electrometer for the Mars '01 robot arm. Martin is a member of the IEEE, Tau Beta Pi, and Sigma Nu. He holds 12 patents and has published over 100 papers.

Ricardo Zebulum is Research Engineer at the Jet Propulsion Laboratory of the California Institute of Technology. He received his Bachelor degree in Electronic Engineering in 1992, his Msc. in Electrical Engineering in 1995, and his PhD in Electrical Engineering in 1999, all of them at the Catholic University of Rio, Brazil. He stayed two years at Sussex University, from 1997 to 1999, as a visiting PhD student. He has been involved with research in Evolvable Hardware since 1996. His research interests also include fault-tolerant systems, low power electronics and analog VLSI design.

Vu Duong is a Master Student at U.C. Irvine. He got his BS in Computer Science from UCSD. During his internship at JPL he programmed the evolutionary hardware test bed using LabView and integrated measurement instruments.