

# COMPARING CRRES INTERNAL DISCHARGE MONITOR RESULTS WITH GROUND TESTS AND PUBLISHED GUIDELINES

A. C. Whittlesey, A. R. Frederickson and H. B. Garrett  
California Institute of Technology Jet Propulsion Laboratory  
Pasadena, CA 91109, USA

## ABSTRACT

Various attempts have been made to reconcile data from the CRRES IDM space experiment, and other space experiments with ground test results, with modeling and with guidelines. Based on recent ground testing supported by the NASA/MSFC SEE program, and other NASA programs, it now becomes easier to reconcile the in-space data with typical ground test data. Recent test data will be described to show how it improves our understanding. Suggestions will be offered for how guidelines may be improved. Suggestions for guideline enhancements will focus on NASA-HDBK-4002 and NASA TP-2361.

## INTRODUCTION

Several spacecraft charging phenomena continue to be unexplained in our opinion. Based upon our recent ground test data it becomes possible to propose further explanations for consideration by the community. In this paper we will discuss the following:

1. *Insulator Bulk Resistivity.* Some unpublished modeling has predicted that the electric fields in the IDM samples should never have produced pulses because the electric fields should not exceed  $1E5$  V/cm. But this modeling was based on resistivity values [1], taken from handbooks, [such as 2, 3] that were much too low. New measurement methods using injection of electric fields with electron space charge find that values for sample resistivity are very high.
2. *Pulse Characteristics Under Irradiation.* The distribution of pulse amplitude as seen on IDM was not like that seen in ground tests using multi-keV to MeV electron beams. The IDM pulses were small. [4] Recent tests find that the pulse rate is an indicator of the static electric field strength in the insulator. Small pulse rates indicate small field strength, of the order  $1E5$  V/cm. And when the field strength is small, the gas burst is small causing only small pulses. The old ground tests produced higher internal electric fields, more rapid pulsing and larger pulses.
3. *Internal Electric Field Effects on Pulse Rate.* The in-flight pulse rate by floating metal surfaces on IDM was less than that of simple floating dielectric surfaces. [4] The twisted shielded pair cable with one floating wire never pulsed on IDM. [4] Yet spacecraft design guidelines point to floating metals as particularly threatening. A review of ground test results [5] found frequent pulsing by a floating metal to occur on only a few of the floating metal samples. The edge of a grounded metal on a dielectric is a better pulse generator than is that of a floating metal. The physics concerning floating metal is not well understood. It may be that electric field strength is the important parameter so that metal interfaces become important only as they influence electric field in the insulator sample.

4. *Relationships Among Electric Field, Pulse Rate and Pulse Amplitude.* Pulse rate on IDM is a function of time in space. [4] It was previously known that PTFE becomes progressively more conductive due to radiation. The IDM found fewer pulses in PTFE after accumulating a few months of dose, in agreement with the prior knowledge where more conductivity reduces electric field, and thereby reduces pulsing. But FR4 produced more pulses after months of space exposure. Recent tests with FR4 find it does not pulse easily at moderate internal field strength ( $1E5$  V/cm) until substantial dose is accumulated. In space, PTFE pulsed for many days before FR4 began to pulse, and then FR4 was a relatively slow pulser for months relative to PTFE. After six months in space, FR4 pulsed frequently. Ionizing dose may improve the ability of FR4 to produce a discharge pulse. Whether this occurs through a change in resistivity, or a change in propensity to pulse is unknown.

## RESULTS

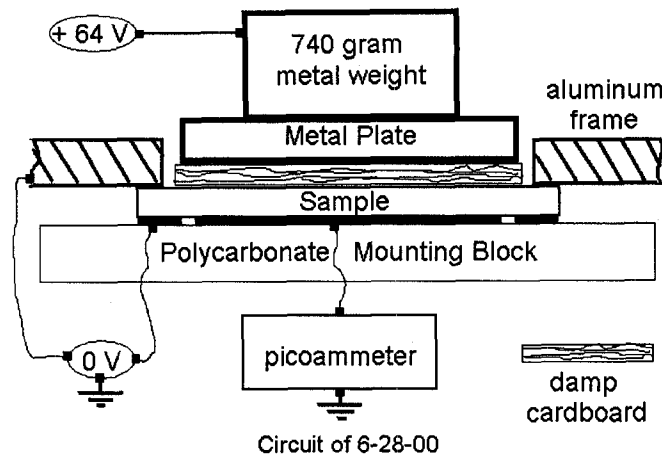
Detailed results for specific ground tests, and comparison to spacecraft data follow.

### I. INSULATOR BULK RESISTIVITY

#### A) Ground Test of Dark Resistivity of Kapton and LaRC-SI Polyimide.

Resistivity values of various magnitudes have been assumed for space applications. Our resistivity measurements performed using the classical conductive electrode method obtained resistivity values of approximately  $1E16$  ohm-cm. After several months in vacuum, the same measurements were repeated and similar results were obtained. Thus, for measurements of this kind in polyimide, time in vacuum may be of little importance. However, as shown below, values of resistivity obtained by using conductive electrodes on the sample may be disturbed by the effects of the metal-insulator interface.

Standard methods for measuring resistivity were simulated in this test. [1] The experiment is described by Fig. 1. Damp cardboard was chosen as a simple electrode that makes contact everywhere to nearly flat surfaces. The consistency of this contact was tested in many ways. The contact pressure (740 grams over the entire sample) was varied a factor of ten larger and ten smaller without changing the results. Tests were made with the cardboard both very wet and air-dried for three days with no discernable difference in the measurement. The condition of very wet cardboard guaranteed that all of the sample surface was in contact with the circuit. The condition of three-day air-dried cardboard produced equally good contact.



**Figure 1. Method for measuring resistivity of the samples.** The inner diameter of the guard ring is 4.77 cm. The laminated circular copper electrode at the bottom of the sample has area of 16.6 cm<sup>2</sup>. The sample thickness is 0.0051 cm. The test was performed in room air. Voltage was varied from +64V to -64V.

The measured currents and resistivities are in the table below. Sample SI is a NASA/Langley polyimide, and KA is commercial Kapton. It is interesting that after being evacuated for three months the currents are a little larger than prior to evacuation. We will not speculate about the reasons for this effect. But it must be remembered that the method involves contacts on the samples with the possibility of injection of ions from the contacts, and therefore memory of prior treatments.

**Table of Sample Currents Using Copper and Cardboard Electrodes**

TIME AT BIAS	SAMPLE SI001	SAMPLE KA001
2 minutes	0.060 nA	0.14 nA
6 minutes	0.030 nA	0.11 nA
10 minutes	0.023 nA, $\rho = 0.88E16$ ohm-cm	0.091 nA, $\rho = 0.23E16$ ohm-cm
4 hours	0.010 nA, $\rho = 2.0E16$ ohm-cm	
7 hours	0.011 nA	
43 hours		0.057 nA, $\rho = 0.37E16$ ohm-cm
123 hours	0.0076 nA, $\rho = 2.7E16$ ohm-cm	

In the second method, keV electrons in vacuum were applied directly to the exposed insulating surfaces of the samples. The electron beam replaced the cardboard contact. After injecting the electrons, the samples were then monitored with a TREK non-contact voltage probe for decay of the resulting surface voltages. The RC time constants of the decays indicated that the resistivities were in excess of 6E18 ohm-cm. This method of measurement is more indicative of the charge leakage properties of the polyimides in space than is the method using a conducting contact on the surface.

The samples were exposed to an electron beam at 2.8 kV allowing electrons to enter the sample surface. At 2.8 kV the beam was not capable of charging a surface beyond 1-kV. Currents from the rear electrodes to ground were monitored during sample charging and

decay measurements. After a charge had built up the beam was turned off and the TREK field probe was moved into position to monitor the sample surfaces. The probe can be moved from one sample to the other.

Results of Test of Kapton Sample:

At 7/14/00/08:44 (at 25 C) the probe read -247 volts on Kapton and at 7/14/00/11:33 (at 44 C) the probe read -247 volts. Thus the Kapton surface voltage did not measurably decay over a 3-hour period.

Results of test of LaRC-SI sample:

<u>Date/time (hours)</u>	<u>actual sample volts</u>
25 degrees centigrade	
7/13/00/17:53      beam off	
7/13/00/17:54	-329
7/13/00/17:57	-328
7/13/00/17:59	-326
7/13/00/18:33	-326
overnight	
7/14/00/08:30	-328
7/14/00/10:30	-329
7/14/00/10:46 begin heating sample	
7/14/00/11:50 sample temp 59 C.	-332
7/14/00/12:30 sample temp 81 C	-336
Is voltage rise due to probe heating or sample expansion, or delayed RIC??	
7/14/00/12:35 begin cooling down from max 83 C.	
7/14/00/17:35 25 degrees Centigrade again	-333.

A 40-volt calibration test was performed several times during the test by un-grounding the back electrode and applying the 40-V to the back electrode. The measured voltage changed by 40 volts, as expected. The probe voltage resolution is +/- 1-volt. Thus the 40-V calibration is good to 3%. As a worst case, assume that the probe drifted by 5% during the 24-hour test. If so, then one may assume that the sample discharged by up to 5% while the probe indicated no discharge. With this assumption we can estimate a lower bound on the time constant and therefore on the resistivity.

Assuming a charge decay of 5% and using the equation:  $e^{-t/\alpha} = .95$ , when  $t=24$  hours and  $\alpha=\rho\epsilon$ ,

$$-t/\alpha = \ln(.95), t = 86,400 \text{ seconds}, \ln(.95) = -0.051$$

$$\alpha = -t/\ln(.95) = \alpha = 1.7E6 \text{ seconds} = 19 \text{ days.}$$

A charge decay time constant of 19 days is the lower bound on our measurements. The measurements do not exclude an infinite time constant! This time constant implies a sample resistivity,  $\rho$ , as follows:

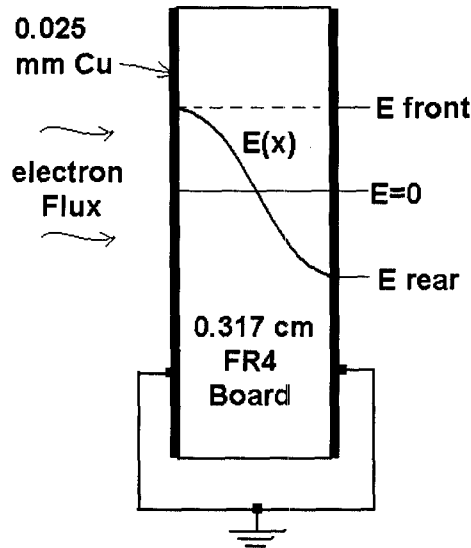
$$\rho\epsilon = (\rho)(8.85E-14F/cm)(3.12) = 1.7E6 \text{ sec}$$

$$\rho = 0.062E20 = 6.2E18 \text{ ohm-cm, or larger.}$$

Such a resistivity is very much larger than the resistivity measured earlier by the classic applied bias method using conducting contacts, and at least a factor of six larger than indicated in the handbooks.

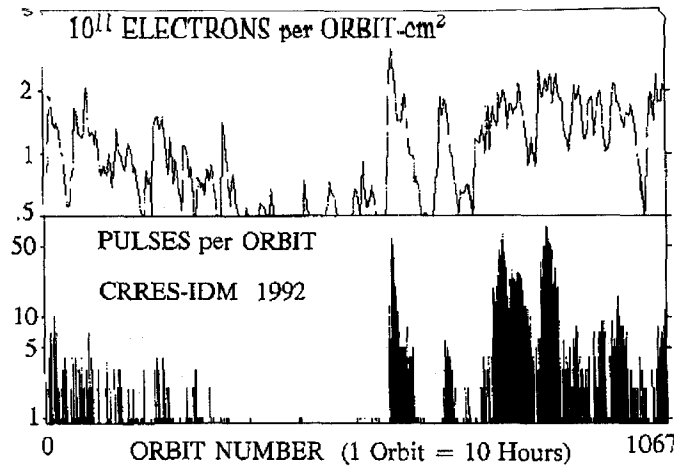
B) CRRES/IDM Space-based Test of Dark Resistivity of FR4 Circuit Board Insulator.

Samples in geometry #4 on IDM/CRRES [4] were modeled using published methods [6, 7], and both the geometry and the electric field is described in Fig 2. This is an FR4 circuit board with copper on both sides. Here it was assumed that the incident electron flux was semi-isotropic ( $2E11$  per ten hour orbit)  $5.56E6$  electrons  $cm^{-2} sec^{-1}$  and with a spectrum  $N(E) = N_0 E^{-4}$ , and with no electrons below 100 keV due to a thin (8-mil) aluminum cover between the sample and space. This flux is similar to the strongest fluxes seen by CRRES as shown in Fig. 3. The sample was measured by the slope method [8] to have a coefficient of radiation-induced conductivity of  $1E-15$  sec  $ohm^{-1} m^{-1} rad^{-1}$ .

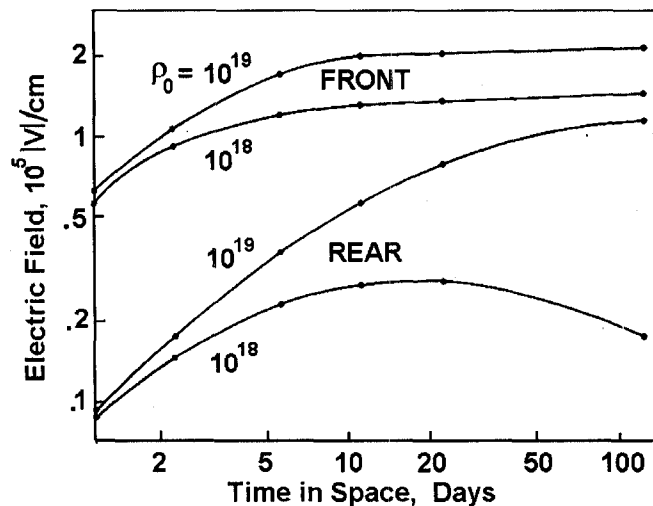


**Figure 2. Description of Electric Field Profile in Geometry #4 on CRRES/IDM.**

As shown in Fig. 2 the electric field magnitude is maximum at the surfaces of the copper, and is designated as E-front and E-rear in the figures. The calculated electric fields E-rear and E-front are provided in Fig. 4. Here, the dark resistivity was modeled with two values:  $1E19$  and  $1E18$  ohm cm. It helps to emphasize that threshold for pulsing occurs at roughly  $1E5$  V/cm. Therefore, if the dark conductivity is much less than  $1E18$ , one would not expect much pulsing in space.



**Figure 3. High-energy Electron Flux incident on the Samples over the Life of CRRES, 1067 Orbits, and Pulse History Summed Over All CRRES/IDM Samples. [4]**



**Figure 4. Calculated Electric Field in CRRES/IDM Sample Configuration 4 for Two Assumed Values of Dark Resistivity (ohm-cm). The Field Units is 1E5 V/cm.**

The pulse history for the geometry 4 sample in space is provided in Fig 5. Based on Figs 2-4 one may conclude the following. The fact that pulses occurred probably indicates that the electric field in the sample attained approximately 1E5 V/cm or more. This is a rough threshold for pulsing in most materials. Also, based on the results in Fig. 4 one may assume that the dark resistivity must have been more than 1E17 ohm cm in the sample when pulsing occurred.

At this point one might be tempted to hypothesize that for the first 200 days the sample may have had a lower resistivity, below 1E17 ohm cm, and therefore did not pulse. However, the next discussion shows that the time delay for pulsing is a radiation effect. Whether the radiation alters electrical conductivity, or provides other conditions which increase the rate of pulsing is unknown.

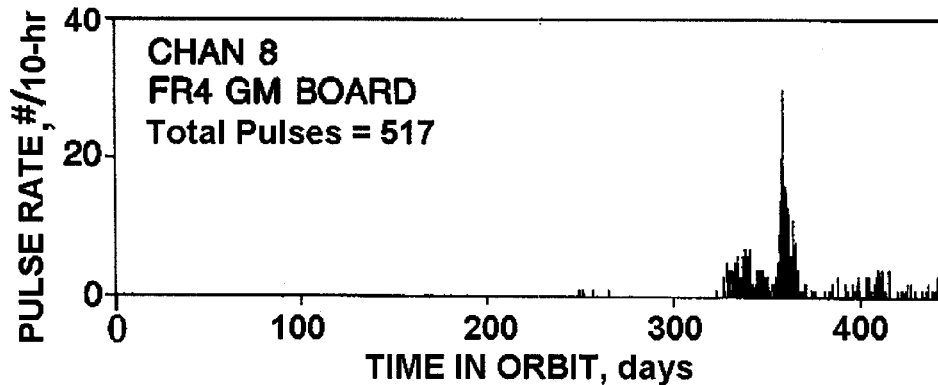


Figure 5. Pulse History for CRRES/IDM Sample Geometry 4. Pulsing begins after 245 days in space. [4]

## II. RADIATION EFFECTS ON INSULATOR PULSING CHARACTERISTICS.

Most of the ground radiation tests were performed with beam current density of approximately  $0.5 \text{ nA/cm}^2$ . The 0- to 35- keV ground test beams irradiated an insulated surface of the sample while the unirradiated side was in contact with a metal, usually copper connected to a 50-ohm oscilloscope. At such current density the surfaces of the samples typically achieve nearly steady state voltage within two minutes of initiating the beam. The surface voltage achieved is typically about 5 kV below the accelerator voltage. Thus the beam energy has a simple relation to the surface voltage. Since the electrons penetrate only a few microns into the sample, the full surface voltage is distributed nearly uniformly throughout the sample thickness.

### A) Radiation Fluence Alters the Pulse Rate of Insulators – Ground Tests.

Impressing a very high voltage, more than  $1\text{E}6 \text{ V/cm}$ , across an insulator would cause rapid pulsing. However, existing space data indicated that pulsing is infrequent and therefore one must conclude that such high electric fields are not impressed on the insulators in flight. An FR4 board with 3.1 mm thickness was chosen for this ground test because the electric field produced by 35 keV electron bombardment in ground tests would not exceed  $31 \text{ kV}/3.1 \text{ mm} = 1\text{E}5 \text{ V/cm}$ . The board had copper covering the back and connected to ground through the 50-ohm oscilloscope. The front of the board, exposed to the beam, was FR4 insulation.

At moderate internal field strength in FR4 circuit board there is a period of time under radiation that is required before pulsing begins. Typical FR4 samples at moderate internal field ( $1\text{e}5 \text{ V/cm}$ ) often do not pulse until they are radiated for a full day. We performed an experiment to determine if the delay is caused by drying-out induced by

vacuum, or some other effect. A sample was allowed to dry out for several days before being tested.

Figure 6 describes the history of the FR4 sample. First, more than 140 hours of vacuum exposure was accumulated prior to radiation. For all of the electron beam exposures, the flux was approximately  $0.5 \text{ nA/cm}^2$ . This flux charges the surface to 25 kV or more within a few minutes, after which the surface remains at high voltage even when a pulse occurs. The pulses do not substantially discharge the surface. The first irradiation occurred about 143 hours after the vacuum was established, and was a 1-hour exposure to 10 keV electrons. The second exposure ramped up the electron energy in several steps to a maximum of 35 keV during a nine-hour period. The third and fourth exposures were each continuous for ten hours at 35 keV. Pulsing did not begin until midway in the third exposure.

The oscilloscope was always set to high sensitivity, trigger threshold set to 0.5 volts or 10 mA, until pulsing began. (The pulse sensitivity on CRRES/IDM was typically about 1-volt on 50-ohms.) The first pulses went off-scale, so the sensitivity was subsequently reduced to keep pulsing on-scale. In this manner, pulses would not be missed. Once pulsing was established, it was remarkably consistent in amplitude.

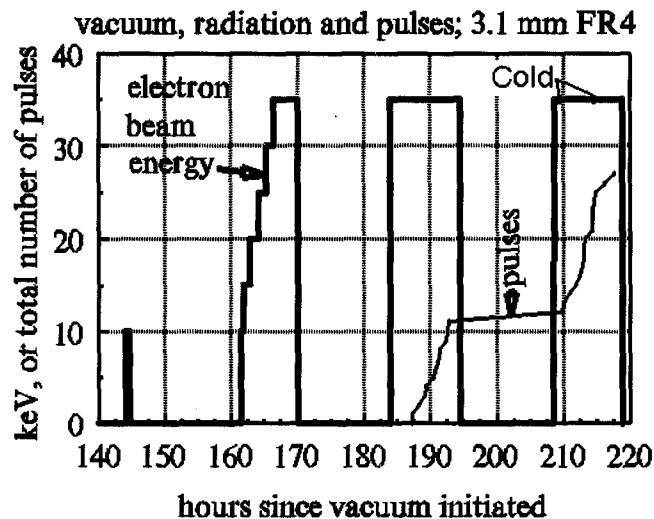


Figure 6. Vacuum and keV Electron Exposure History of the FR4 Sample. When the beam was on, the flux was  $0.5 \text{ nA/cm}^2$ .

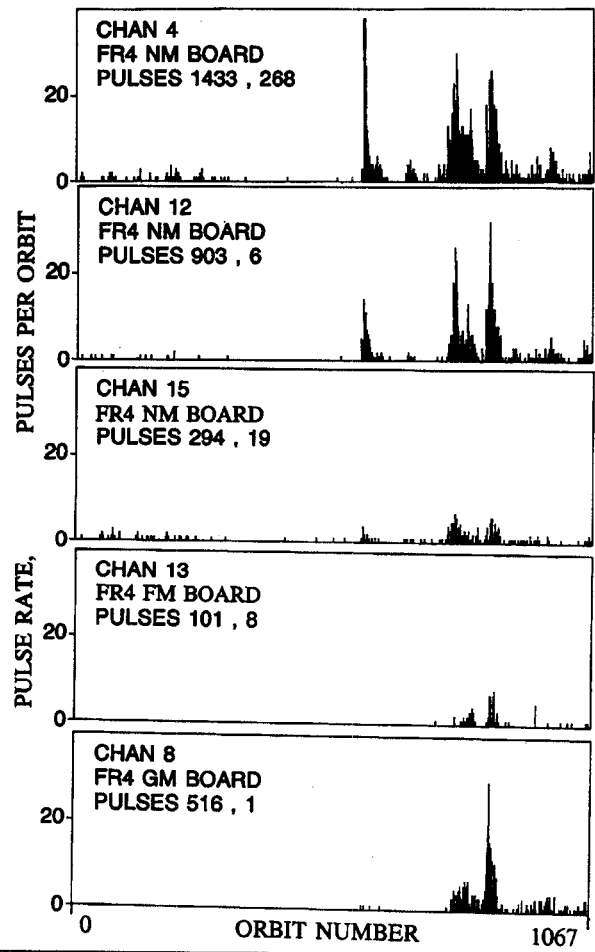
PTFE Teflon has also been studied in ground tests. The conductivity of PTFE Teflon has been seen to increase as radiation accumulates. [9] Therefore one would expect pulsing to decrease as fluence increases in PTFE.

**Conclusion:** FR4 Circuit board must accumulate some radiation dose before it easily pulses, in this case 13 hours at  $0.5 \text{ nA/cm}^2$  of perhaps 10 keV electrons, or roughly  $1.5 \times 10^{14} \text{ e/cm}^2$ . PTFE Teflon becomes more conductive as radiation fluence increases and therefore should experience decreasing electric field and decreasing pulse rate with increased fluence. This is consistent with the space data from CRRES.



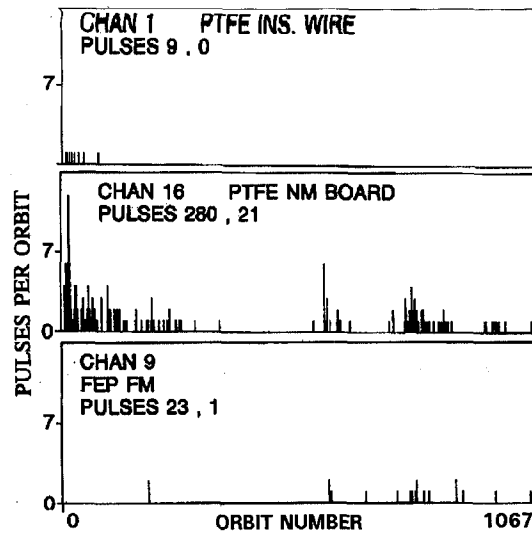
B) Radiation Fluence Alters the Pulse Rate of Insulators – CRRES/IDM in Space.

Figure 7 shows the history of FR4 circuit boards in space. The samples with the designator NM (no metal) have the open front surface similar to samples that produced the data in Fig. 6. The designator FM means floating metal on the front, and GM means the front was grounded metal as in Fig. 2. The electron flux history for all CRRES/IDM samples is provided in Fig. 3. Pulsing on these samples dramatically increased after exposure to  $4E13$  e/cm<sup>2</sup>. The CRRES/IDM electron flux was provided primarily by electrons in the range 200 keV to 500 keV. It is no surprise that (compared to 10 keV electrons) fewer of these are required in order to alter the dielectric and thereby enhance pulse rates.



**Figure 7. Pulse Rates for the FR4 Circuit Board Samples on CRRES/IDM.**

On CRRES/IDM the PTFE circuit board sample showed frequent pulsing early in the flight, decreasing dramatically as dose accumulated. This can be seen in Fig. 8. Thus the PTFE material behaved in space as if its increase in conductivity as radiation fluence accumulated caused a reduction in the pulse rate. Presumably the pulse rate decreased because the electric field decreased.



**Figure 8. Pulse Rates on Teflon and Other Samples on CRRES/IDM.** Both the Teflon Wire and the Teflon Circuit Board Pulsed Less Frequently as Fluence Accumulated in Space. Note that the FEP Teflon did not behave similarly. It does not become much more conductive with increased fluence.

### III. DEPENDENCE OF PULSE RATE ON INTERNAL ELECTRIC FIELD

#### A) Ground Tests of Pulse Rate vs. Internal Electric Field.

FR4 circuit board, four samples of each thickness, was tested at 30 keV beam energy with three thicknesses: 3.18 mm, 1.58 mm and 0.8 mm. First the samples were radiated until a stable rate of pulsing developed. The two thicker boards were irradiated at 0.5 nA/cm<sup>2</sup>. The thinnest board was irradiated at 0.1 nA/cm<sup>2</sup> in order to keep the pulsing slow enough for the scope and data-compiling computer to keep up with it. At this low flux it takes longer to recharge the sample surface and develop the strong electric field after a pulse, thereby slowing the apparent pulse rate.

Knowing the beam energy, one may estimate the electric field strength in the sample. The pulse rate data for the three thickness are provided in Fig. 9. The curve is dashed because the dead-time effect at the high beam energy makes it difficult to evaluate both the actual pulse rate and the electric field. It is clear that the pulse rate depends on electric field.

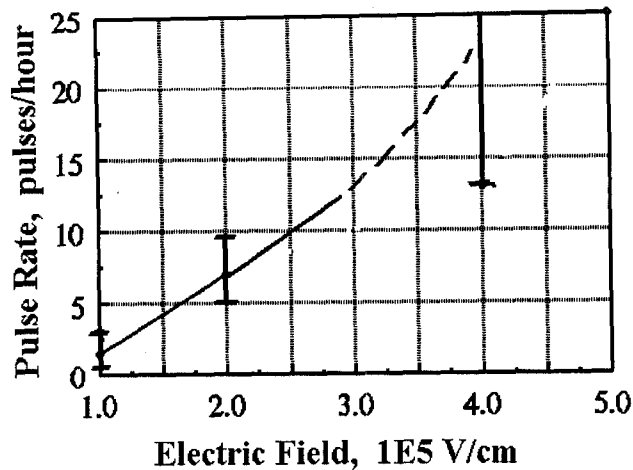


Figure 9. Pulse Rate on FR4 Board in 30 keV Ground Tests.

B. CRRES/IDM In-space Pulse Rates.

Figure 10 provides a summary of the CRRES/IDM pulse rate data. This information is also implicit in Figs. 3, 7 and 8. The vast majority of the CRRES/IDM pulses were generated by FR4 circuit board. The amount of material under test in Fig. 10 was roughly equivalent to the amount of material under test in Fig. 9. From Fig 10 we see that the in-space maximum pulse rate was 8 pulses per hour, very close to the pulse rate in Fig 9 at 2E5 V/cm.

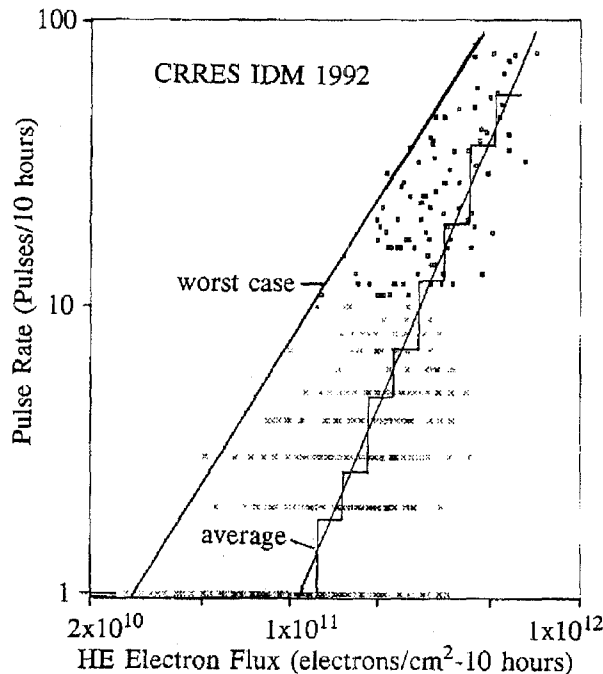


Figure 10. Pulse Rate on CRRES/IDM.

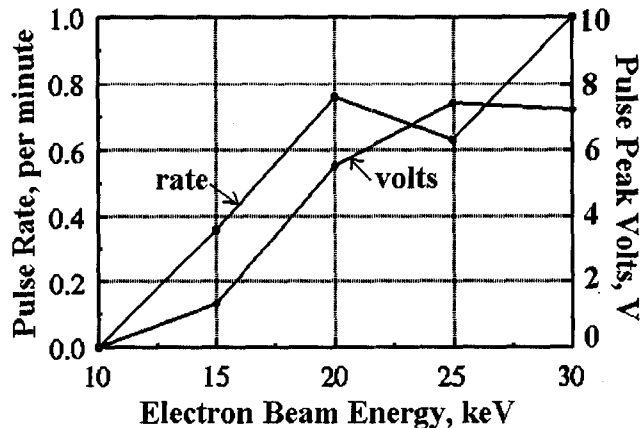
At an electron flux of  $2E11 \text{ e/cm}^2 - 10 \text{ hrs}$ , Fig 10 indicates a pulse rate of 0.5/hr. However, Fig. 4 indicates that for this flux on CRRES the electric field internal to

grounded FR4 is of the order  $1E5$  V/cm. Figure 9 suggests that at this field strength the pulse rate will be of order 2/hr, a remarkably similar result to Fig. 10. This level of agreement encourages us to continue to pursue ideas about characterizing pulse rate as a function of electric field. Here, pulse rate correlates better with electric field than with high-energy electron flux.

#### IV. RELATIONSHIP BETWEEN PULSE AMPLITUDE AND EITHER ELECTRIC FIELD OR PULSE RATE.

##### A) Ground Tests of Pulse Amplitude and Pulse Rate.

A cable bundle test was performed at 0.5 nanoamperes per square centimeter at electron beam energies from 10 keV to 30 keV. With cables it is difficult to estimate the internal electric field and the surface voltage because the geometry is so complex. It suffices to know that in this energy range the insulation is not penetrated by the electrons, and the surface potential and internal electric fields scale approximately with electron beam energy. Being cylindrical and irradiated by a plane parallel beam, various parts of the insulation are at various voltages and electric field strengths. Figure 11, a graph of pulse rate and peak amplitude with respect to electron beam energy, indicates that rate and amplitude both scale together with electric field strength. This relationship has been found to be similar in all data sets where it is possible to analyze the data in this manner.



**Figure 11. Dependence of Pulse Rate and of Pulse Voltage Upon Beam Energy.**  
Beam energy is a surrogate for internal electric field.

##### B) CRRES/IDM data for Pulse Amplitude and Pulse Rate.

CRRES did not accurately measure the amplitude of the pulses. Basically, one can only discriminate between two amplitudes (small and large) on most of the CRRES samples. [4] Although it has not been done, it would be possible to compare the two pulse amplitudes with electron flux on CRRES. It would also be possible to predict electric field as a function of flux, in a fashion similar to that in Fig. 3. Higher flux provides higher field, which in turn would be expected to provide larger pulses. This comparison remains to be done, but the data exists in the CRRES files.

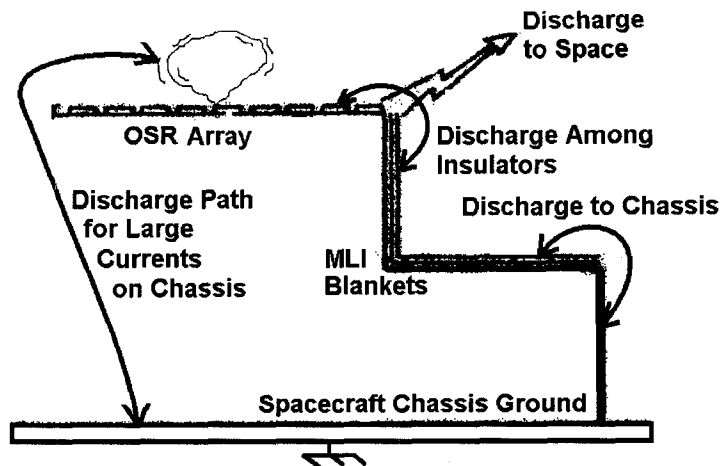
#### V. IMPROVING HANDBOOKS AND GUIDELINES

Guidance for preventing/mitigating spacecraft charging is currently provided by NASA-HDBK-4002 [10] for internal electrostatic discharge, and by NASA TP-2361 [11] for surface charging. These guidelines provide a valuable methodology for limiting the effects of spacecraft charging. Data accumulated since these reports were prepared, however, indicate that the following modifications should be considered for future updates:

For NASA TP-2361: At the time this guideline was prepared, the details of the arcing process were not well defined. Recent research also indicates that there are several other arcing scenarios than the one presented in Figs. 5-8 of TP-2361, and that these may be more realistic for predicting a system's response to a discharge. The concern here is that the one example provided in TP-2361 overestimates the pulse amplitude for many spacecraft situations, but may underestimate it for special cases. It may lead to expensive over-design in some cases if the analyst is not highly sophisticated. Experience shows that common sources of arcs (see below) include intra-surface pulses and interior pulses. Future guidelines need to provide methods for determining the probability for occurrence of each of the discharge arcing scenarios to help in designing and testing spacecraft. A final issue is that test techniques (not part of the original Guideline) need to be standardized for evaluating the new materials that are being developed.

For HDBK-4002: As in the case of surface discharges, several recent developments allow us to make better estimates of internal electrostatic discharges. In particular, since the publication of the Handbook, electric field strength inside insulators has been found to be the major determinant of pulse magnitude and discharge rate. Methods for calculating this internal field strength and the distribution of pulse currents on circuits have also been refined, but need further research. Real in-space pulse rate data are available that can be compared to pulse rates from ground tests. Finally, improved data on electrical conductivity in insulator materials should be obtained in order to predict the charging of particular materials.

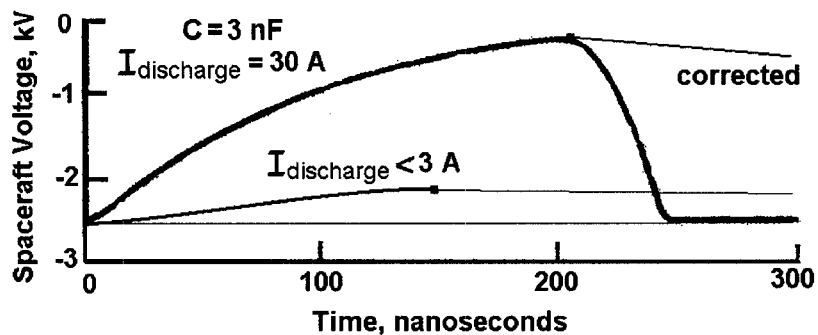
Here we will briefly consider further the effect of new arc scenarios as opposed to the scenario in TP-2361. Sections 2.3-2.4 of NASA TP-2361 provide a sample case analysis as an exercise. A portion of a spacecraft composed of OSR solar array, MLI, and spacecraft ground was shown for an example as the source of a discharge. The discharge to space originates with one of the two insulators as shown in Fig. 12. While this is certainly one arc scenario, alternate discharge current paths also exist which may be likely. These are indicated on a revised version of the original Guidelines plot, Fig. 12.



**Figure 12. Surface Discharge Current Paths on a Typical Spacecraft.** The MLI is presumed to be shaded from the sunlight.

The objective in evaluating the effects of these surface discharges is to determine the discharge current which flows to sensitive circuits located on the spacecraft chassis. Here, in addition to the Guidelines arc, we consider, as illustrated in Fig. 12, discharges among insulators, discharges to the nearby chassis, and a discharge path for currents over long distances on the chassis. The discharge among insulators causes a local current to flow in the metal directly attached to the insulators, but little current at large distances. This current consists of a redistribution of the existing image charges in the metal ground planes on the insulators, but negligible current beyond that region. Provided that no wiring passes near this region, there will be little signal impressed on sensitive circuits. Another discharge path is from the MLI to nearby chassis. This also produces only a local current flow. The discharge to space and the discharge to distant points on the chassis may, however, produce large currents on the chassis near sensitive wiring.

In it's Fig. 8, NASA TP-2361 estimates the pulsed discharge current to space from the voltage waveform of Fig. 13 to be 30 A. 30-A pulses are indeed seen in the lab when the sample is very thin (typically 0.005 cm) and has very high voltage across it (typically 15 kV) with very large internal field (here  $3E6$  V/cm), more than  $1E6$  V/cm. Recent testing with more representative spacecraft dielectric internal electric fields, however, indicates that pulses will normally be much less than 3 A. ( In passing, it should be noted that spacecraft recharge over a period of milliseconds to seconds as indicated by the "corrected" lines in Fig. 13.) For practical purposes, the designer needs to determine whether simulations should assume a worst case 30 A pulse or the potentially more nominal, 3 A pulse. Additionally, the designer should determine which of the four (or more) discharge paths occur as depicted in Fig. 12 in order to determine coupling to sensitive circuits.



**Figure 13. Predicted Discharge Current from NASA TP-2361.** A large spacecraft would require a 3 nF capacitance to space plasma ground to produce the 30-A discharge in Fig. 8 of NASA TP-2361. Assuming this to be possible, lab tests of MLI and OSR have measured discharge currents of 30 A provided that the electric field in the MLI is very high. However, in what are now believed to be more representative spacecraft arcing configurations, recent lab tests imply that the pulses will be like the lower curve in the figure--e.g., smaller than 3 A. Realistic internal fields produce the smaller pulses. Furthermore, when spacecraft are at high charging voltage they are often at low capacitance to plasma, thus reducing the discharge to space even more severely.

Another issue to consider in future guidelines is that the surface voltages should be calculated by including the contribution of charge by currents inside the insulators together with the currents from the space plasma. Specifically, currents and voltages inside the insulators are equally important in determining both differential spacecraft charging voltages and arcing characteristics as are the external currents. Further, in typical situations the electric fields inside spacecraft insulators appear to be of order  $1E5$  V/cm, not  $1E6$  V/cm. As a result, based on recent tests at  $1E5$  V/cm, real pulses will typically be much smaller than previous estimates ( $<3$  A as opposed to 30 A).

Lab tests of samples producing 30-A pulses have been found to experience a rapid pulse rate of many pulses per hour. A large internal field strength of  $1E6$  V/cm during the lab tests is believed to be responsible for the rapid pulse rate. To date, such high rates have been seen only rarely in space. [12-17] SCATHA observed arcing rates of 1/min on only 2 days out of  $\sim 2.5$  years, the spin rate of the spacecraft, and higher rates during electron beam operations. This is believed to be further evidence that electric fields in surface insulators are normally much less than  $1E6$  V/cm.

Differential surface voltage has been measured on SCATHA, DSCS [14,15,17-19] and other spacecraft. Here the measured surfaces were separated by large distances (several mm or more) from the spacecraft grounds. Because the distances were large, only small electric fields in the insulators were necessary to develop the measured high differential voltages. Specifically, differential voltage of several kV over several mm of distance provides only  $1E4$  V/cm.

CRRES experienced many periods of high surface charging, and many anomalies. [20] Surface potential was monitored independently by a Langmuir probe, and by a low-energy proton spectrometer. None of the anomalies occurred when the surface was

charged more than 30 volts [20] although the spacecraft was charged to over 1 kV for substantial time periods. This is another indication that the few surface insulators on CRRES may not have been stressed.

## CONCLUSIONS

1. Resistivity values of insulators in space may be much higher than values tabulated from ground based testing that used metal electrodes on the material.
2. Resistivity of insulators in the space environment is altered by environmental effects and thereby the patterns of pulsed discharging are changed. In order to provide meaningful ground tests, one must carefully consider this possibility when designing the tests.
3. The rate at which some insulating materials initiate discharge pulse events may be altered by total dose effects independent of changes in resistivity.
4. The pulse rate increases rapidly as the internal electric field in the insulator increases above  $1E5$  V/cm.
5. The pulse amplitude also increases rapidly as the internal electric field in the insulator increases above  $1E5$  V/cm.
6. Ground test data may be used to predict the pulse rate in space within an order of magnitude. To do this, one needs to: 1) measure the resistivity of the sample, including radiation-induced conductivity, 2) calculate the electric field generated in the sample under space conditions, and 3) measure the pulse rate in ground tests where the same internal electric field is generated. This procedure successfully matched the pulse rate observed on CRRES.
7. Pulse rate appears to be well correlated with pulse amplitude such that it may be an indicator of electric field strength inside the insulator.
8. Sufficient pulse discharge characteristics are now known to allow for more concise testing and design guidelines to be proposed.

## REFERENCES

1. ASTM D-257-91, Standard Test Methods for D-C Resistance or Conductance of Insulating Materials, February 22, 1991.
2. The Guide to Plastics, by the Editors of Modern Plastics Encyclopedia tabulates the resistivity of polyimides as " $>1E16$ ."
3. W. Tillar Shugg in Handbook of Electrical and Electronic Insulating Materials, 2nd Ed. tabulates polyimide resistivity as "E18."
4. A. R. Frederickson, E. G. Holeman and E. G. Mullen, "Characteristics of Spontaneous Electrical Discharging of Various Insulators in Space Radiations," *IEEE Trans. Nuc. Sci.* 39, 1773-82, December 1992.
5. P. G. Coakley, M. J. Treadaway and P. A. Robinson, Low Flux Laboratory Test of the Internal Discharge Monitor Intended for CRRES, *IEEE Trans. Nuc. Sci.* 32, 4066-72, Dec. 1985.
6. A. R. Frederickson, Charge Deposition, Photoconduction, and Replacement Current in Irradiated Multilayer Structures, *IEEE Trans. Nuc. Sci.* NS22, 2556-2561 (1975)



7. A. R. Frederickson, S. Woolf and J. C. Garth, Model for Space Charge Evolution and Dose in Irradiated Insulators at High Electric Fields, IEEE Trans. Nuc. Sci. 40, No. 6, 1393-1401, Dec, 1993.
8. A. R. Frederickson, "Radiation Induced Currents and Conductivity in Dielectrics", IEEE Trans. Nuc. Sci NS24, 2532-9 (1977).
9. A. R. Frederickson, "Irradiation Effects on Charge Storage in Teflon", Proceedings 1981 Conference on Electrical Insulation and Dielectric Phenomena, pp. 45-51, IEEE Publ # 81 CH1668-3 (1981).
10. Avoiding Problems Caused by Spacecraft On-orbit Internal Charging Effects, NASA-HDBK-4002, 17 Feb 99.
11. C. K. Purvis, H. B. Garrett, A. C. Whittlesey and N. J. Stevens, Design Guidelines for Assessing and Controlling Spacecraft Charging Effects, NASA TP-2361, 1984.
12. H.C. Koons, P.F. Mizera, J.L. Roeder, and J.F. Fennell, "Severe Spacecraft-Charging Event on SCATHA in September 1982," *J. Spacecraft Rockets*, 25, no. 3, 239-243, 1988.
13. H. C. Koons and D. J. Gorney, "Relationship Between Electrostatic Discharges on Spacecraft P78-2 and the Electron Environment," *J. Spacecraft and Rockets* 28, 683-8, 1991.
14. L. J. Lanzerotti, K. LaFleur and C. G. MacLennan, Geosynchronous spacecraft charging in January 1997, *Geophysical Research Letters* 25, 2967-70, Aug. 1998.
15. P. F. Mizera, A Summary of Spacecraft Charging Results, AIAA-82-0268, Amer. Inst. Aeronautics and Astronautics, N.Y., NY, January, 1982.
16. N. J. Stevens, V. W. Klinec and J. V. Gore, Summary of the CTS Transient Event Counter Data After One Year of Operation, NASA-TM-73710, 1977.
17. D. J. Rodgers, Correlation of METEOSAT-3 Anomalies with Data From the Spacecraft Environment Monitor, European Space Agency - ESTEC Working Paper No. 1620, 1991.
18. E. G. Mullen, M. S. Gussenhoeven, D. A. Hardy, T. A. Aggson, B. G. Ledley and E. Whipple, SCATHA Survey of High-Level Spacecraft Charging in Sunlight, *J. Geo. Res.* 91, No A2, 1474-90, 1986.
19. E. G. Mullen, A. R. Frederickson, G. P. Murphy, K. P. Ray, E. G. Holeman, D. E. Delorey, R. Robson and M. Farar, "An Autonomous Charge Control System at Geosynchronous Altitude: Flight Results for Spacecraft Design Consideration," IEEE Trans. Nuc. Sci. 44 (6), 2188-94, Dec. 1997.
20. M. D. Violet and A. R. Frederickson, "Spacecraft Anomalies on the CRRES Satellite Correlated with the Environment and Insulator Samples," IEEE Trans. Nuc. Sci. 40, No. 6, 1512-20, Dec., 1993.