

Thermal Stability of the AVIRIS On-Board Calibrator

Jessica Faust, Michael Eastwood, Chuck Sarture, Orlesa Williams
Jet Propulsion Laboratory
California Institute of Technology
Pasadena, California 91109

Introduction

The AVIRIS On-Board Calibrator (OBC) provides essential data for refining the calibration of each AVIRIS data run. Annual improvement to the AVIRIS sensor and laboratory calibration accuracy has resulted in increasingly high demands on the stability of the OBC. Since the 1995 flight season, the OBC could track the stability of the spectrometer alignment to the 2% level, a significant improvement over previous years. The major contributor to this 2% stability was the conversion from a constant-current bulb power supply to an intensity-based active feedback power supply. Given the high sensor signal-to-noise ratio, improving the OBC to track 1% or 0.5% changes was highly desirable. Achieving stability better than 2% required an examination of the mechanisms affecting stability.

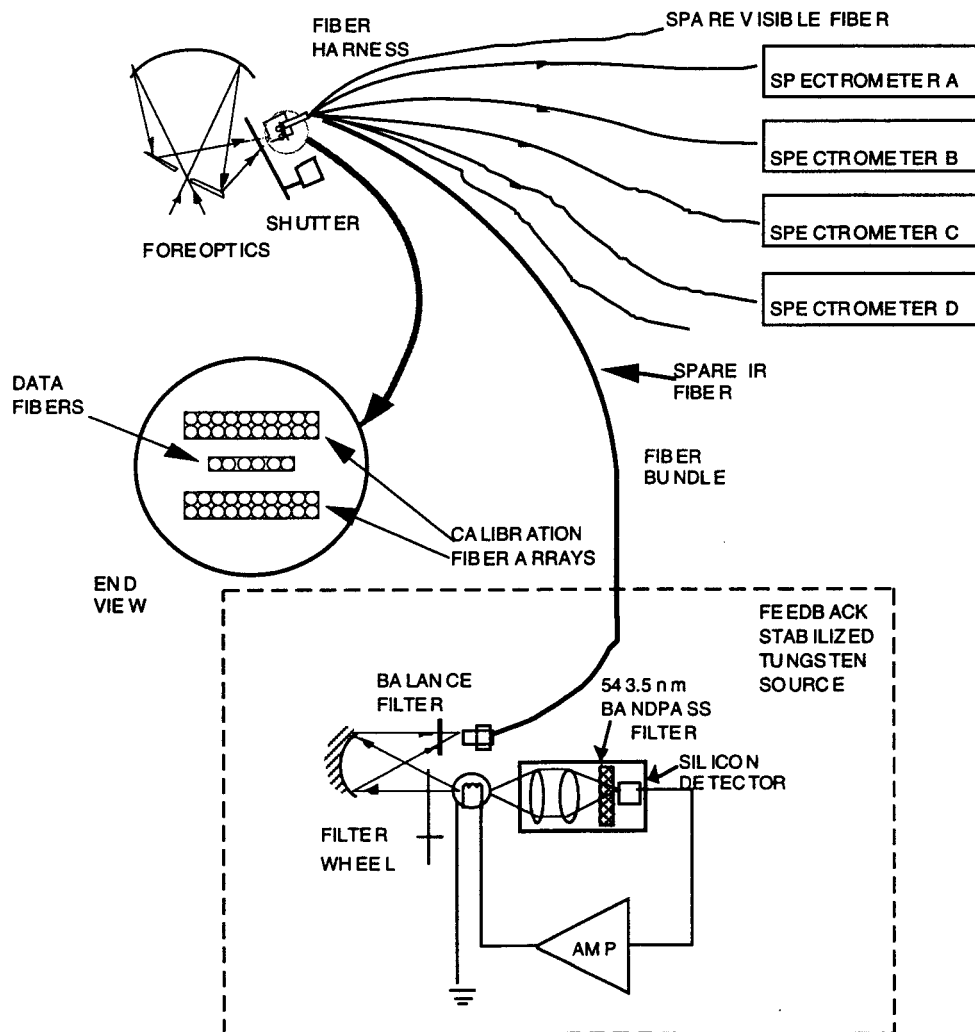

Figure 1. On-Board Calibrator Layout

Historically, the OBC temperature has ranged between $+10^{\circ}\text{C}$ and $+50^{\circ}\text{C}$, in-flight minimum and in-laboratory maximum, respectively. Optical power variations caused by changes in the temperature of the OBC are seen by the AVIRIS spectrometers and degrade the utility of the OBC as a calibration source. The goal of thermal testing the AVIRIS OBC was to quantify any changes in the optical output from the optical fiber bundle as the temperature of its environment changes.

The on-board calibrator and its place in the AVIRIS sensor is shown in figure 1. When the foreoptics shutter is closed light from the feedback stabilized tungsten source in the on-board calibrator is carried through a fiber bundle to the back of the shutter and reflected into the spectrometer data fibers. Fluctuations in the OBC temperature can distort the OBC structure, causing the tungsten lamp to mis-align and hence change the intensity of the light reaching the spectrometers. The change in temperature of the OBC in-flight has historically been as much as $\pm 10^{\circ}\text{C}$.

Experimental Set-Up

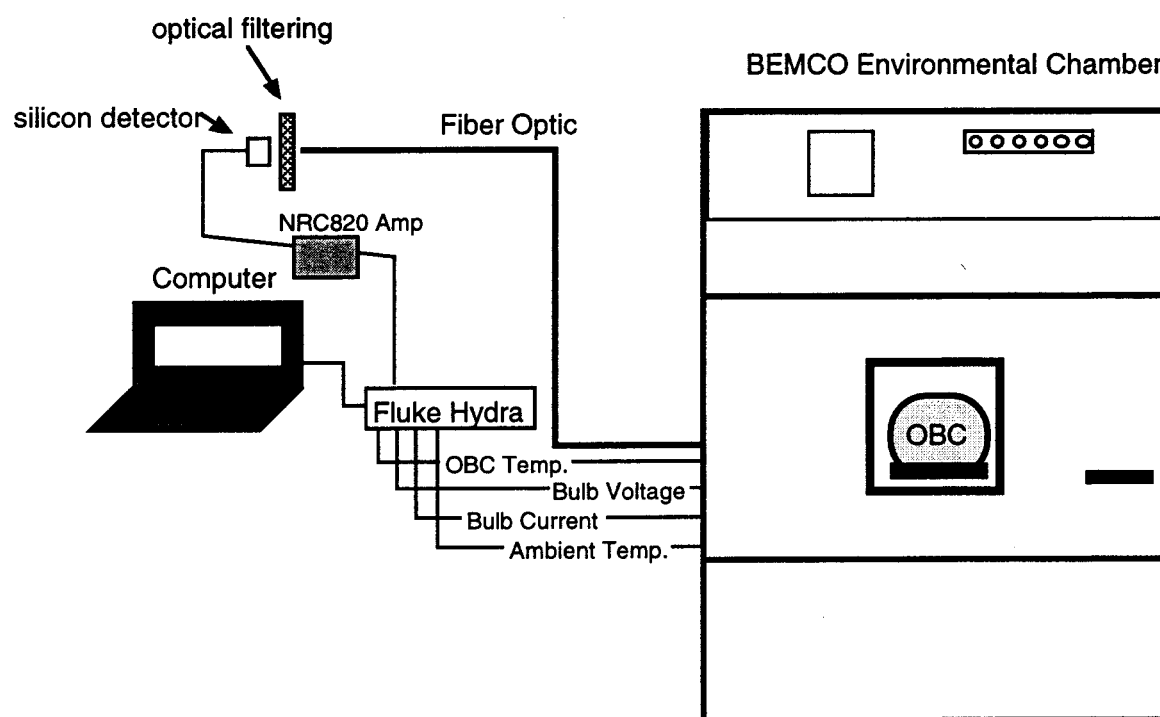

Figure 2. Experimental Set-Up

The OBC was placed in an environmental chamber such that thermal contact between the chamber floor and the calibrator was eliminated; therefore, chamber air provided the thermal transport as opposed to point contact with the cold chamber walls (see figure 2). Optical fiber and power cables were fed through an opening and attached to the OBC. Several OBC operating parameters were monitored, including light output through the optical fiber, voltage across the light bulb, voltage across a 0.1Ω resistor series (bulb current), plus both OBC structure and ambient temperature ($10\text{ mV}/^{\circ}\text{C}$). Data was logged to an ASCII file using a Fluke Data Acquisition Unit. Optical power output was monitored by a model NRC820 silicon detector with an optical filter and stored to the data file (output was measured as volts DC on an arbitrary scale).

Procedure and Analysis

The test was performed four times with improvements to the set-up added each time. For the first run, the OBC was not mounted on an aluminum plate (as usually configured on AVIRIS) and the temperature range was 10°C to 50°C. In this run, the OBC output varied with small changes in temperature. Figure 3 shows oscillations in the OBC output over regions where the OBC structure temperature is fairly stable. The bulb voltage and current followed closely with the rise and fall of the temperatures and showed oscillations as well, but at significantly smaller magnitudes. The oscillations in the lamp current are 1 mA in 2000 mA and 2 mV in 5000 mV for the bulb voltage. This is a power variation of 2 parts in 10^7 while the optical flux at the output of the fiber bundle varied 3 parts in 10^3 .

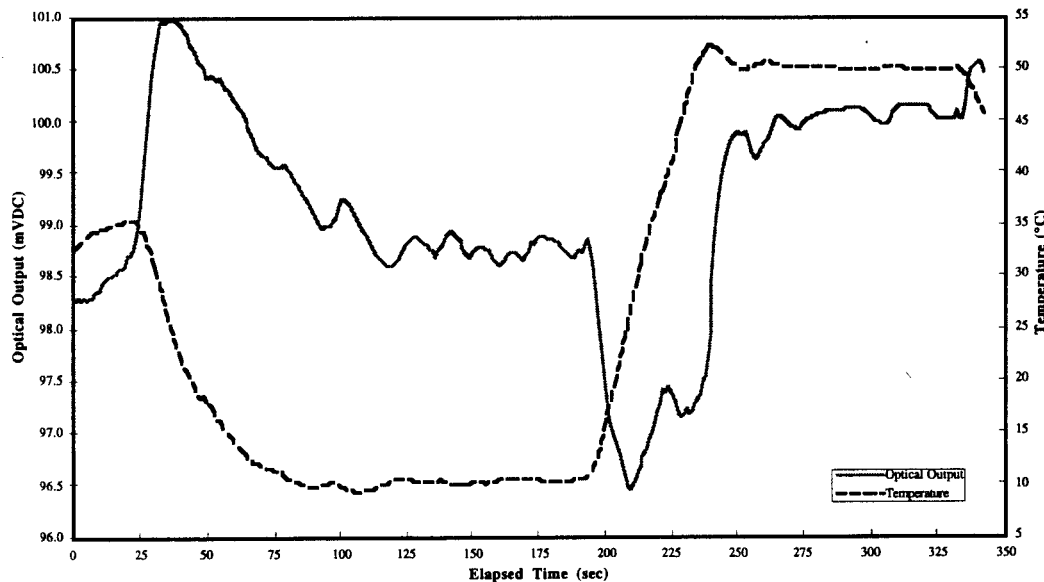

Figure 3. First Run: Optical Output and Temperature vs. Time for OBC without a shear plate

As shown in figure 1, the lamp output is imaged onto the fiber bundle by a spherical mirror after passing through the filter wheel. If the base plate of the OBC distorts, then the optical components will misalign, and the image of the bulb filament will move off the fiber bundle input. This is the most likely cause of the oscillations seen in figure 3.

For the second run, an aluminum plate was attached to the base of the OBC to more closely simulate the enhanced structural rigidity of the OBC baseplate when it is attached to the AVIRIS sensor's forward panel in the normal flight configuration. The test was terminated before completion because the temperature sensor readout became noisy and unstable. The addition of a filter to the circuit at the data acquisition unit eliminated this noise. The third test ranged in temperature from 20°C to 40°C (equilibrium was not achieved at 40°C). A 10 nm FWHM, 450 nm center wavelength bandpass filter was added to minimize any room temperature responsivity variations from the NRC820 silicon detector.

The fourth run was done over the same temperature range as the first run, adding another temperature equilibrium region at 30°C (See Figure 4.). The equilibrium regions lasted for at least 45 minutes and did not show the oscillations that were visible in the first test. In this test, the OBC output was much more stable than in the first test.

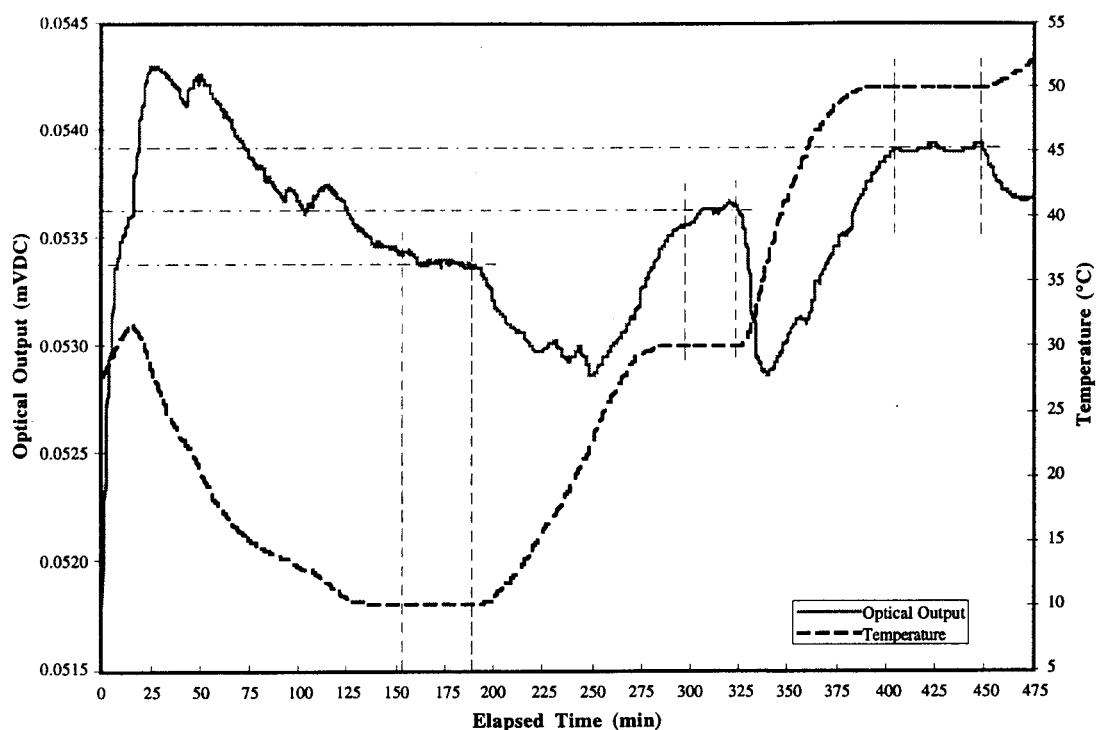

Figure 4. Fourth Run: Optical Output and Temperature vs. Time (with a shear plate)

Conclusion

A change in OBC structure temperature of 40°C leads to a change in optical output of approximately 4% at 450 nm. Last year, the in-flight temperatures ranged between 25°C and 45°C. If we assume AVIRIS will experience similar temperature variations in the future, the 20°C range would continue to yield an OBC light output uncertainty of 2%. However, for regions where the temperature is stable the optical output variation is far less than 2%. This is because temperature transients generate gradients that distort the OBC structure and misalign the optics. Once the OBC reaches thermal equilibrium, the optical alignment is re-established, as is evident in the fourth test where the output deviation was approximately 0.75% across each of the three temperature stable regions. Bulb voltage and current followed the temperature changes very closely, indicating that the 543.5 nm filtered silicon detector controlling the bulb has a residual output sensitivity to temperature, or that the structure holding the bulb in alignment with that detector is not perfectly rigid. (see Figures 5. and 6.) From these results, we decided to implement a thermal control system to stabilize the OBC's internal temperature to 40°C. This thermal stabilization will further limit the variations in optical output to well below the 0.75% seen in the test.

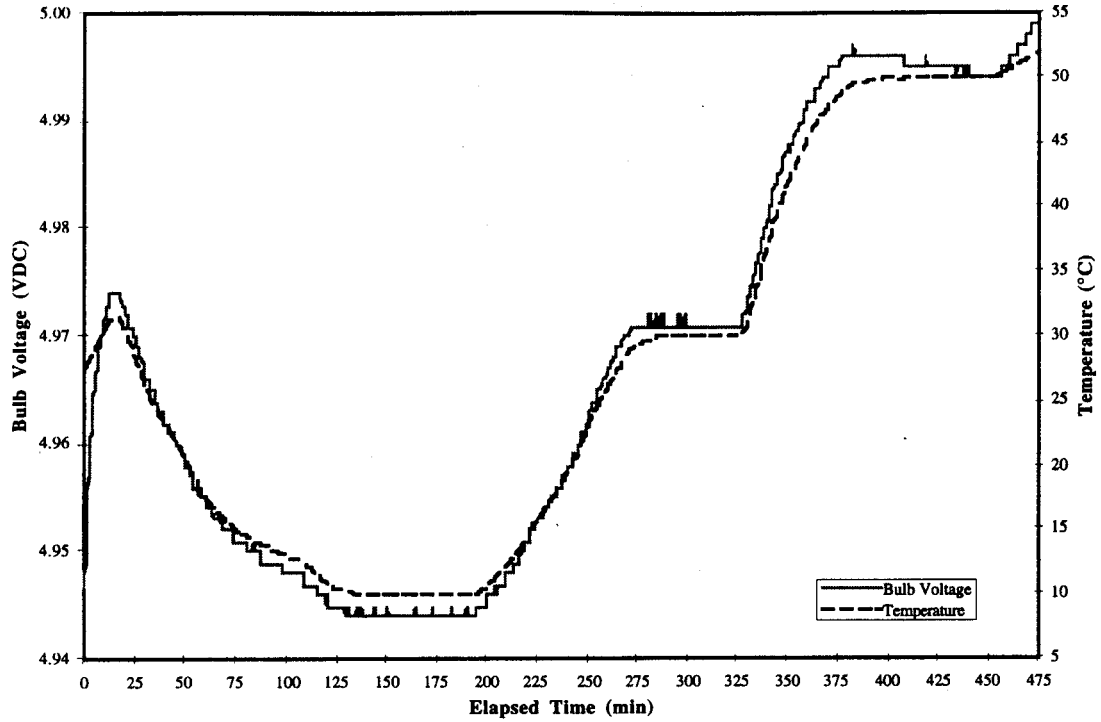

Figure 5. Bulb Voltage and Temperature vs. Elapsed Time

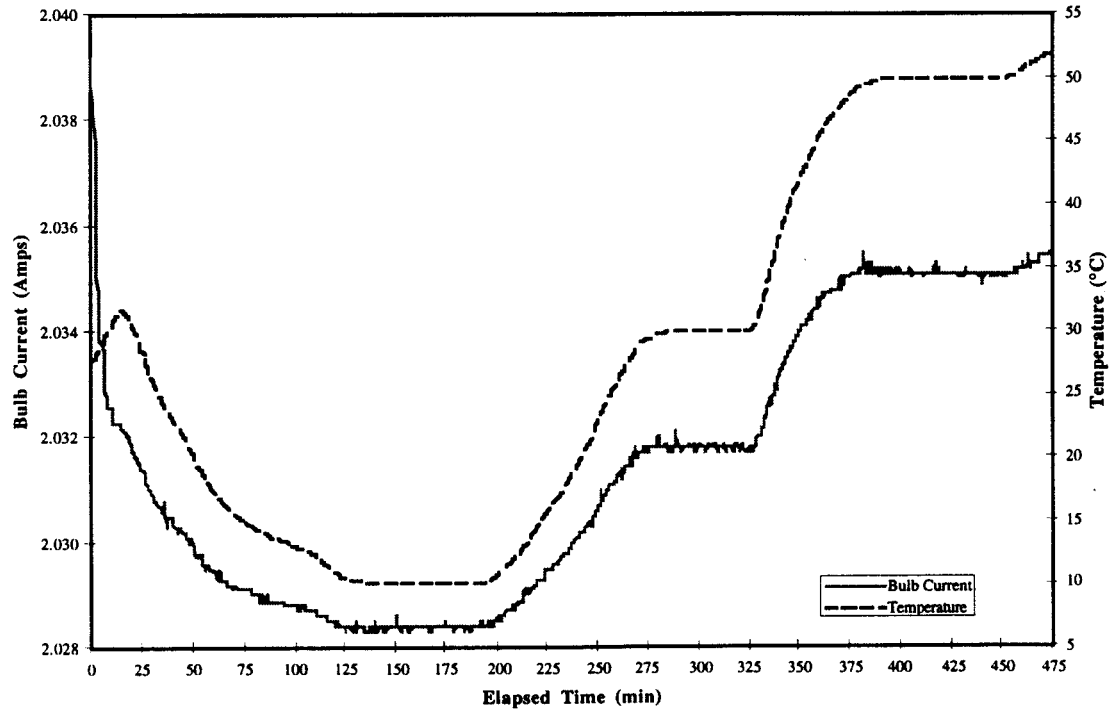

Figure 6. Bulb Current and Temperature vs. Elapsed Time

Data from the flight season, as seen in figure 7, shows that the variation in the lamp voltage was 0.47% while the lamp current varied by only 0.19%. This slow increase in bulb voltage and current could arise from the slowly decreasing bulb quartz envelope transmittance as tungsten is deposited on inside of the envelope. The halogen cycle does minimize this deposition, but does not completely eliminate it. This increasing opacity would result in less light exiting the bulb for a given power level. The intensity-based closed-loop control compensates for this by increasing the power, thus the bulb output is maintained. A slight color temperature change also results, but is not significant for the variation seen here.

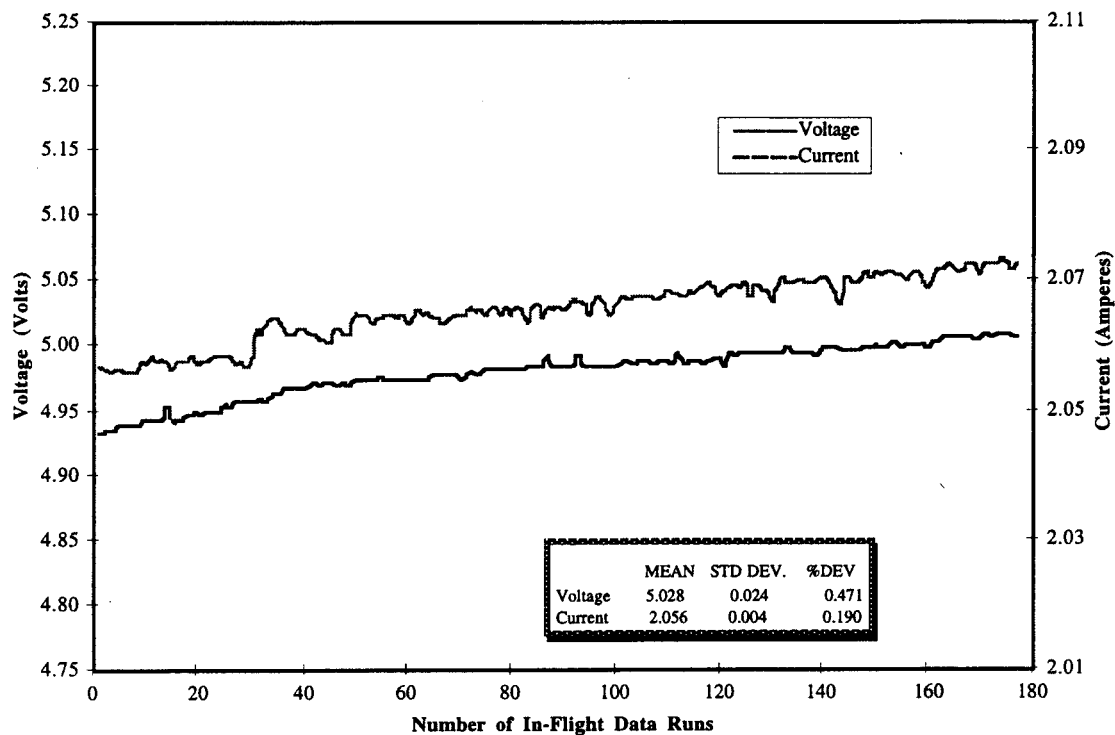

Figure 7. On-Board Calibrator Lamp Current and Voltage Trend for 1997 Flight Season

The research described in this paper was carried out by the Jet Propulsion Laboratory under a contract with the National Aeronautics and Space Administration.