

STABILIZED REFERENCE FREQUENCY DISTRIBUTION FOR RADIO SCIENCE WITH THE CASSINI SPACECRAFT AND THE DEEP SPACE NETWORK

M. Calhoun, R. Wang, A. Kirk, W. Diener, G.J. Dick, and R.L. Tjoelker
Jet Propulsion Laboratory, MS 298-100
4800 Oak Grove Drive, Pasadena, CA 91109, USA

Abstract

A high performance frequency distribution system which includes two key technologies, the Stabilized Fiber Optic Distribution Assembly (SFODA) and the Compensated Sapphire Oscillator (CSO), has been developed to provide state of the art frequency reference in the NASA Deep Space Network (DSN). This frequency distribution system was developed to enable sensitive gravity wave searches and occultation experiments between earth based antennas in the DSN and the Cassini spacecraft. The experiments, to be conducted at S, X, and Ka band, require the highest possible frequency stability over observation times from 1 second to 1 day. The DSN frequency and timing subsystem generates and distributes coherent signals to multiple antennas up to 30 km away. The SFODA measures and compensates for distribution related phase perturbations and the CSO provides short term stability cleanup and low phase noise at the antenna.

This paper provides an overview and update of the end to end high performance frequency and timing subsystem. Focus is given to the final SFODA design and test results using a 16 km optical fiber under controlled test conditions. Test data show a factor of 1000 improvement in long term stability when the active phase compensator is used thus enabling degradation free distribution from the highest performing atomic frequency standards. Recent measurements between two CSO standards are also presented.

INTRODUCTION

A series of ambitious radio science experiments are planned between the NASA Deep Space Network(DSN) and the Cassini spacecraft both in the spacecraft cruise phase and when in orbit around Saturn [1]. For maximum sensitivity these experiments, which include gravity wave searches on a two way Ka band Doppler link and one way occultation experiments with the spacecraft ultra-stable oscillator, require the highest stability frequency references and distribution available. In the DSN, the source of the frequency reference signal is typically a hydrogen maser or a mercury Linear Ion Trap Frequency Standard (LITS) [2]. Although the atomic frequency standards operate in an environmentally controlled room at the Signal Processing Center (SPC) the low-noise, high stability signals are needed at the spacecraft tracking antennas which may be thousands of meters from the frequency standard. Frequency distribution systems which carry signals to the antennas can be subject to temperature extremes, electromagnetic and radio frequency interference, and vibration. The distribution challenge is to preserve atomic frequency standard long term stability to all antennas and, for the case of the Cassini occultation experiments, improve close in phase noise.

NEED FOR FIBER STABILIZATION

For antennas located near the Signal Processing Center (SPC) the reference frequency stability is distributed through a special optical fiber with a low thermal coefficient of delay (LTCD). The thermal coefficient of delay is typically less than 1 ppm/°C for temperatures below 35°C, and near 0.1 ppm/°C over the range 10°C

to 25°. This cable is not suitable for direct burial applications and its cost limits implementation to antennas close to the SPC. Remote antennas, up to 30 km from the central SPC, are serviced by direct burial fiber optic cables. Since the remote antennas are not equipped with the LTCD fiber they do not meet the very stringent radio science stability requirements. The 34 meter antenna DSS-25, selected for Ka band support of the Cassini radio science mission, is 16 km from the central SPC. The thermal coefficient of the distribution optical fiber is approximately 7 ppm/°C and exposed to a number of temperature variations.

The ground temperature profile at the California DSN site is shown in Figure 2 [3]. These ground temperature profiles were measured with thermocouples at depths of 2 feet, 3 feet, 4 feet, 5 feet, and 6 feet between the months of January and June. The line in Figure 2 with the larger variations from day to day is the surface temperature averaged over a 24 hour period. The existing fiber optic cable from the SPC to DSS-25 is buried at a depth of approximately 1.5 meters. At this depth the fiber is sufficiently insulated from short term and daily thermal perturbations. Unfortunately, regions of the fiber are exposed along the 16 km path. There are 4 access vaults, each of which hold approximately 10 m of coiled cable. These vaults have steel covers and are exposed to large air temperature variations, as great as 50° C peak-to-peak. Additionally, the fiber cables pass through an air plenum at the SPC, the plenum at the remote station, and the antenna pedestal at DSS-25. Temperature cycling in the air plenums and pedestal varies and has been observed to be as great as 2° C peak-to-peak with varying periods, typically in the 2000 to 4000 second range. All of these factors can contribute to phase delay variations measured at the user end of the distribution system. Figure 3 shows the measured Allan deviation of the distribution at antenna DSS-25 when the phase delays are uncompensated.

FREQUENCY REFERENCE SYSTEM

Early prototype development of the two key technologies, the Stabilized Fiber Optic Distribution Assembly (SFODA) and the Compensated Sapphire Oscillator (CSO) have been previously discussed [4]. Figure 1 shows the block diagram of the reference frequency distribution system to the remote Beam Wave Guide (BWG) antenna, DSS-25. The driving force for the development of the SFODA was temperature induced phase delay variations in optical distribution links. The design of the actively stabilized reference frequency distribution system is based on optical closed loop feedback. A reference frequency signal at 1 GHz is transmitted over the fiber link and the SFODA utilizes active feedback with a temperature compensating fiber optic reel to compensate for thermally induced phase variations over the 16 km fiber cable. The optical transmitter is a commercial, single-mode distributed feedback laser diode with an integral optical isolator. The companion optical receiver with a phase lock loop and distribution amplifiers are located at the remote antenna. The distribution can deliver 100 MHz or 1 GHz to steer the CSO or to supply other users as needed. The CSO and SFODA receiver are both located in a special environmentally controlled building near the base of the antenna DSS-25. The temperature within this building is controlled to ±50 millidegrees C.

The planetary occultation and gravity wave radio science measurements place stability requirements on the frequency distribution system of 1.5×10^{-16} between 1000 and 3600 second averaging times. The short term stability requirement is 3×10^{-15} at one second. The SFODA has sufficient signal to noise to preserve atomic frequency standard stability at distances up to 30 km providing the long term stability to meet Cassini sensitivity goals for gravity wave detection. The SFODA short term stability is approximately 1.5×10^{-14} at one second, which falls short of the frequency reference requirements for occultation measurements. These occultation experiments measure phase and amplitude fluctuations of the S, X, and Ka band carriers resulting from transit through intervening media, such as the rings of Saturn or the atmosphere of Titan. For these measurements the CSO is phase locked to the 100 MHz SFODA output providing a short term reference stability of 3×10^{-15} from 1 second to 100 seconds. The CSO was developed to provide practical, continuous operation for a year at a time using a closed cycle refrigerator [5]. If desired, the CSO can also serve as a local oscillator to achieve the highest performance possible with passive atomic frequency standards [6].

STABILIZED FIBER OPTIC DISTRIBUTION ASSEMBLY

The atomic frequency standard located at the SPC is used as the source of a highly stable signal, typically 100 MHz, and distributed to users of the Deep Space Network tracking stations. Local distribution (internal to the SPC) of these stable signals is through high quality coaxial cables. Reference frequencies to nearby 34m and 70m antennas are distributed via fiber optic links utilizing the LTCD fiber previously discussed. For the remote antenna locations, direct burial optical fiber is the preferred medium of distribution. Optical fibers offer the advantages of low loss, EMI/RFI immunity, and broad bandwidth.

A detailed block diagram of the SFODA is shown in Figure 4. The SFODA utilizes active feedback and a thermally controlled reel of fiber to offset the thermal variations in the 16 km fiber cable between the stations. The major components at the SPC are the power supply, master controller, a bipolar power supply to both heat and cool the compensating reel, and the compensating reel. The electronics package in the master controller is mounted on a thermally controlled plate. The signal input to the master controller is 100 MHz from the on-line frequency standard. This signal is split and multiplied to 1 GHz for transmission over the fiber link. The X10 multiplier is a phase-locked cavity oscillator with low phase noise. The second output of the multiplier is used as a reference to a phase detector which produces the phase error signal. The reference signal modulates the 1310 nm laser diode with the 1 GHz carrier. The optical output utilizes an optical isolator and an optical circulator, allowing two way transmission on a single channel fiber. The channel fiber, one of a 96 fiber cable, is standard SMF 28, single mode with a temperature coefficient of delay of 7 ppm/°C.

At the remote antenna site, the optical signal goes into a receiver where the 1 GHz modulation is detected and amplified for distribution. The 1 GHz signal phase-locks a 100 MHz low-noise voltage controlled oscillator (VCO). The output of the 100 MHz VCO is coherent with the signal from the on-line frequency standard and is available for distribution. The CSO, when steered to the 100 MHz input provides the required short term stability at the antenna.

Figure 5 illustrates the Allan deviation achieved with the SFODA and Figure 6 shows the system stability performance with and without compensation while in an environmental chamber programmed to generate 1°C temperature swings once every 24 hours. Tests in the laboratory as well as preliminary in-situ tests indicate a factor of 1000 improvement in the long term stability of the reference frequency distribution over a distance of 16 km.

COMPENSATED SAPPHIRE OSCILLATOR

Cryogenic oscillators operating below about 10K offer the highest possible short term stability of any frequency sources. However, their use has so far been restricted to research environments due to the limited operating periods associated with liquid helium consumption. The Compensated Sapphire Oscillator (CSO) has been developed for ultra high short term stability and low phase noise [5,6]. With cooling provided by a commercial cryocooler instead of liquid helium, this standard is designed to operate continuously for periods of a year or more.

This development was enabled in part by a new generation of two-stage Giffard-McMahon cryocoolers which allow operation at temperatures down to 4.2K. Previously, such temperatures could only be achieved by the use of an additional Joule-Thompson expansion stage, with increased complication and cost, and with reduced reliability. Any cryocooler generates vibration which, if coupled to a high-Q electromagnetic resonator will degrade frequency stability. Sufficient vibration isolation is accomplished by using turbulent convection in a gravitationally stratified helium gas.

Cryogenic standards have used both superconducting and sapphire resonators to achieve the $Q > 10^9$ required for 1×10^{-15} frequency stability. Superconducting resonator Q's degrade to unacceptable values above about

2K. Q's of a billion have been previously measured in whispering gallery sapphire resonators at temperatures up to 10K. However the temperature sensitivity of sapphire resonators is so large that high stability can only be attained near a preferred turnover temperature where the slope of frequency versus temperature approaches zero. The actual value of the turnover for any given resonator depends on the concentration of incidental paramagnetic impurities as well as the properties of the electromagnetic mode that is being excited. The CSO resonator design compensates the frequency variation of a whispering-gallery sapphire resonator by means of a thermally attached ruby element. The high chromium concentration in the ruby provides a means for adjustable external compensation by varying its position with respect to the sapphire element. With this ruby element, sapphire turnover temperatures are raised from typical as-supplied values of 5-6K to a reproducible 8-10K resulting in a practical continuously operating standard at the 10^{-15} level.

The CSO provides low phase noise at 10 GHz and continuous operation for up to one year. Phase noise tests between two independent CSO's (Figure 7) show a 24-28 dB improvement over hydrogen masers in the frequency range of 1 Hz to 40 Hz. Figure 7 also shows some harmonics of the 2.4Hz refrigerator cycle which were previously masked by maser noise. Figure 8 shows a direct high stability measurement against a hydrogen maser of 2.5×10^{-15} between 300 and 600 seconds. Also shown is direct pair data between two CSO's. Currently three CSOs are operational. A total of four will reside in the DSN, one at each complex (Goldstone, California USA; Madrid, Spain; and Canberra, Australia) to act as low noise reference for the antennas close to the Signal Processing Centers. A fourth will operate at the end of the SFODA distribution link (Figure 1) at the remote antenna DSS-25 to clean up the limiting phase noise and short term stability of the atomic standard distribution link.

CONCLUSIONS

Stability measurements indicate that the 100 MHz reference frequency signal for radio science experiments meets or exceeds needed performance. This will enable a new generation of low frequency gravity wave searches using a two way Ka band Doppler link between the NASA Deep Space Network and the Cassini Spacecraft. Environmental temperature effects on the distribution fiber to the DSN Ka band antenna, DSS-15, have been reduced by measuring and actively stabilizing the 16 km optical fiber link. Short term stability and phase noise requirements are met by use of a continuously operating Compensated Sapphire Oscillator.

Presently, two SFODAs are operational in the Deep Space Network at Goldstone, California. One is operating between the SPC and DSS 25 to support the Cassini Radio Science experiments and the second installed between the SPC and DSS 13, a distance of 28 km, also in support of Cassini related experiments to calibrate the effect of the Earth's troposphere. Two CSOs are in preparation for delivery to Goldstone which will take place upon completion of the environmental facility at DSS 25, in February 2001.

ACKNOWLEDGEMENTS

This work was carried out at the Jet Propulsion Laboratory, California Institute of Technology, under a contract sponsored by the National Aeronautics and Space Administration.

REFERENCES

1. M. Tinto, "Requirements" in Cassini Radio Science Ground System Cost and Schedule Review", JPL Document, June 19, 1997.
2. R.L. Tjoelker, C. Bricker, W. Diener, R.L. Hamell, A. Kirk, P. Kuhnle, L. Maleki, J.D. Prestage, D. Santiago, D. Seidel, D.A. Stowers, R. L. Sydnor, T. Tucker, "A Mercury Ion Frequency Standard Engineering Prototype for the NASA Deep Space Network," Proc. of the 50th Annual Symp. On Frequency Control, Honolulu, Hawaii June 5-7, 1996.
3. M. Calhoun, J.C. Law and P.F. Kuhnle, "Environmental Effects on Optical Fibers Used for Reference Frequency Distribution", Proceedings of the Institute of Environmental Sciences Applications Meeting, Las Vegas, NV, May 1993.
4. M. Calhoun, G.J. Dick, and R.T.Wang, "Frequency Transfer and Cleanup System for Ultra High Stability at Both Long and Short Times for Cassini Ka Band Experiment", Proceedings of the 30th Annual Precise Time and Time Interval and Applications Meeting (PTTI) , Reston, VA, December 1998.
5. Rabi T. Wang and G. J. Dick, " Stability Tests of Three Cryo-cooled Sapphire Oscillators ", pp. 190-191, Proceedings of the Conference on Precision Electromagnetic Measurements 2000, 2000.
6. G. John Dick, Rabi T. Wang, and Robert L. Tjoelker, "Cryo-cooled Sapphire Oscillator with Ultra-High Stability," Proc. Of the 52th Annual Symp. On Frequency Control, Pasadena, CA, June 1998.

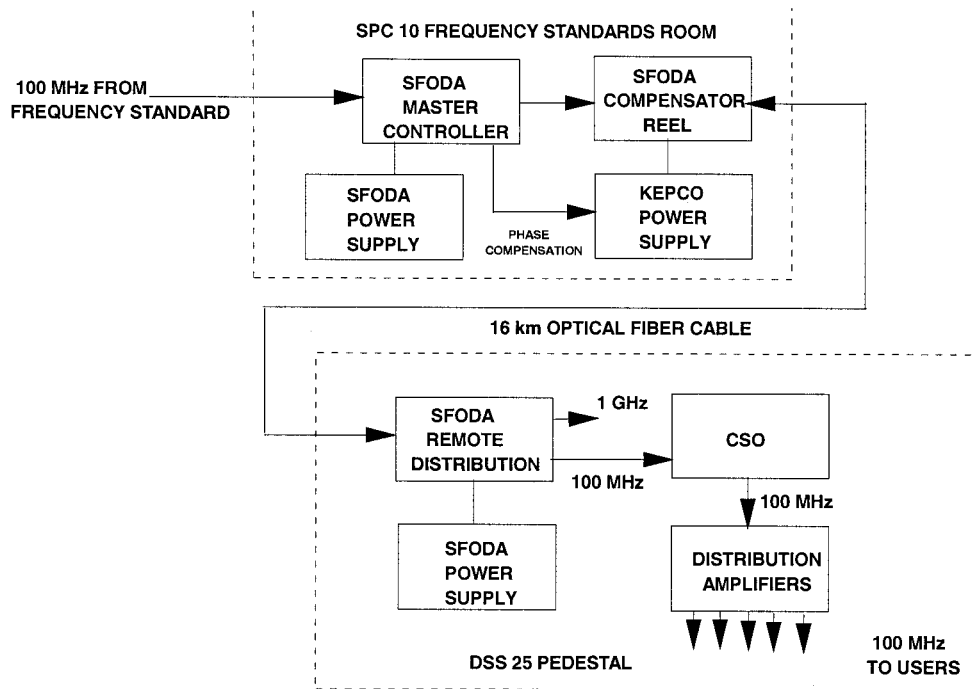

Figure 1. Block diagram of 100 MHz reference frequency distribution at the Deep Space Network tracking station (Goldstone, California) between the Signal Processing Center SPC-10 (location of the atomic frequency standard) and the Ka-band transmit/receive antenna DSS-25.

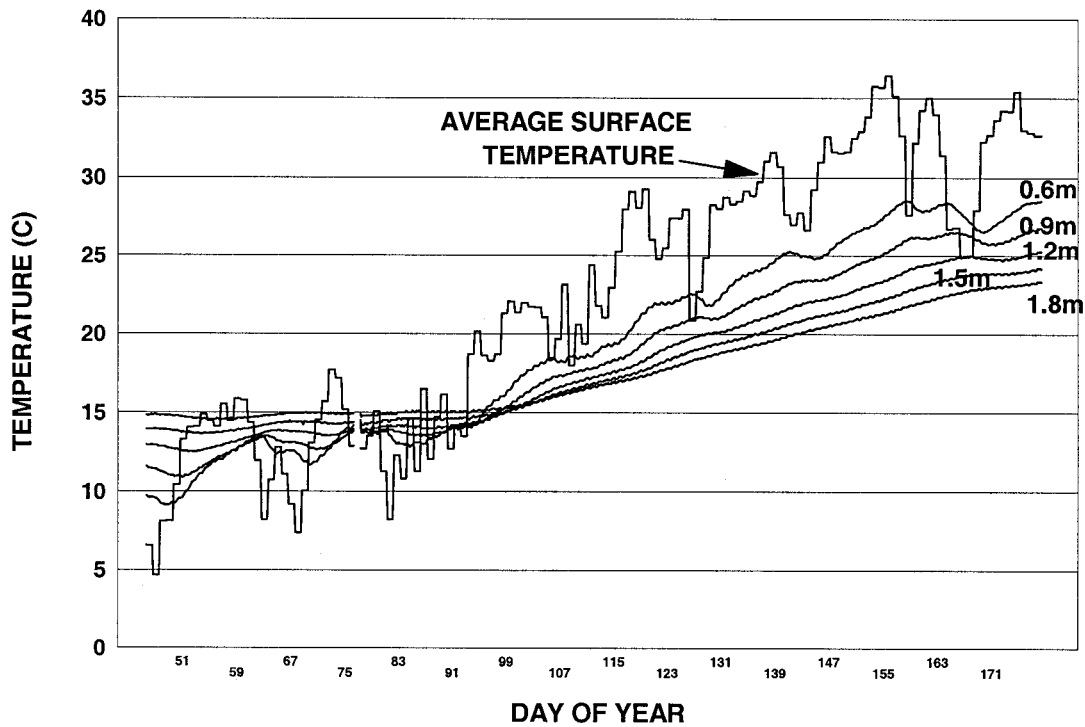

Figure 2. Ground temperature at Goldstone Deep Space Communications Complex at different depths over time.

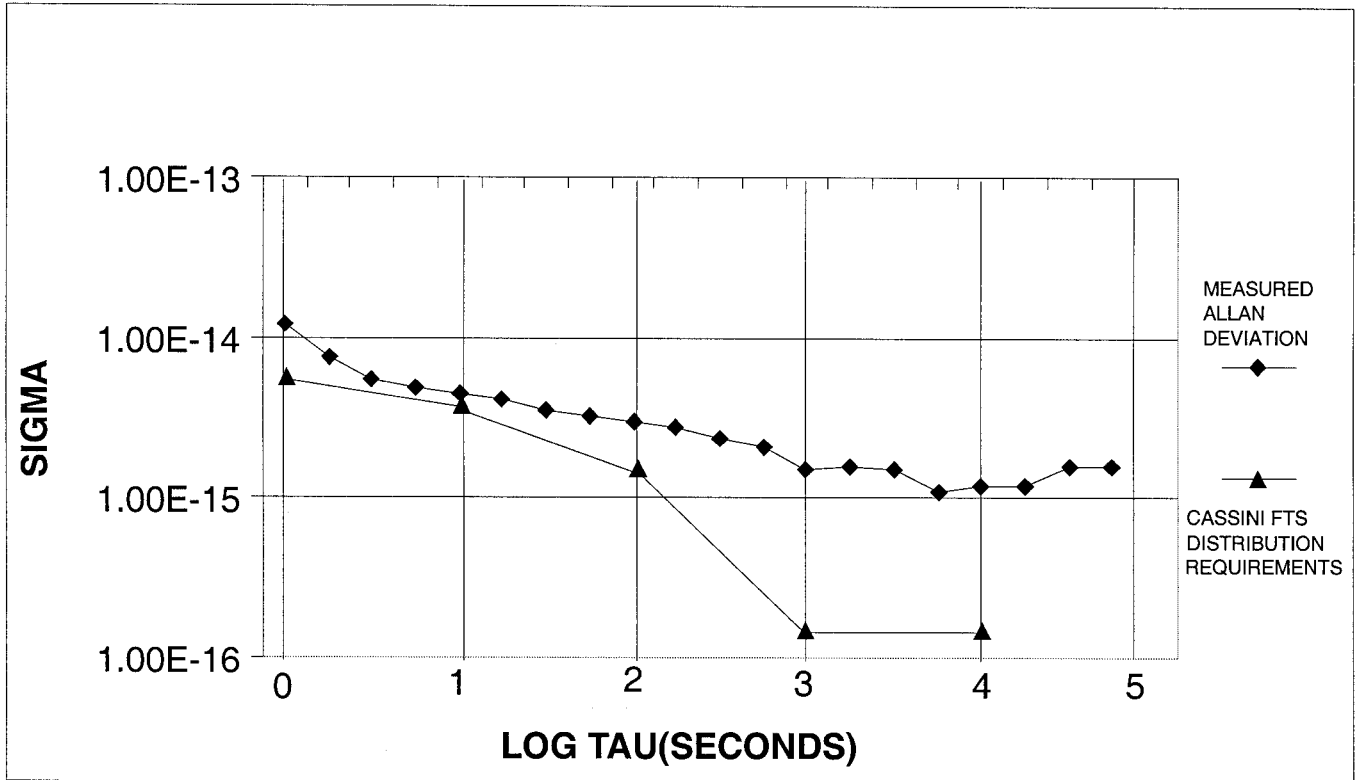

Figure 3. Allan Deviation of the 100 MHz Reference frequency measured at the remote antenna DSS-25 before installation of the compensated fiber optic distribution system.

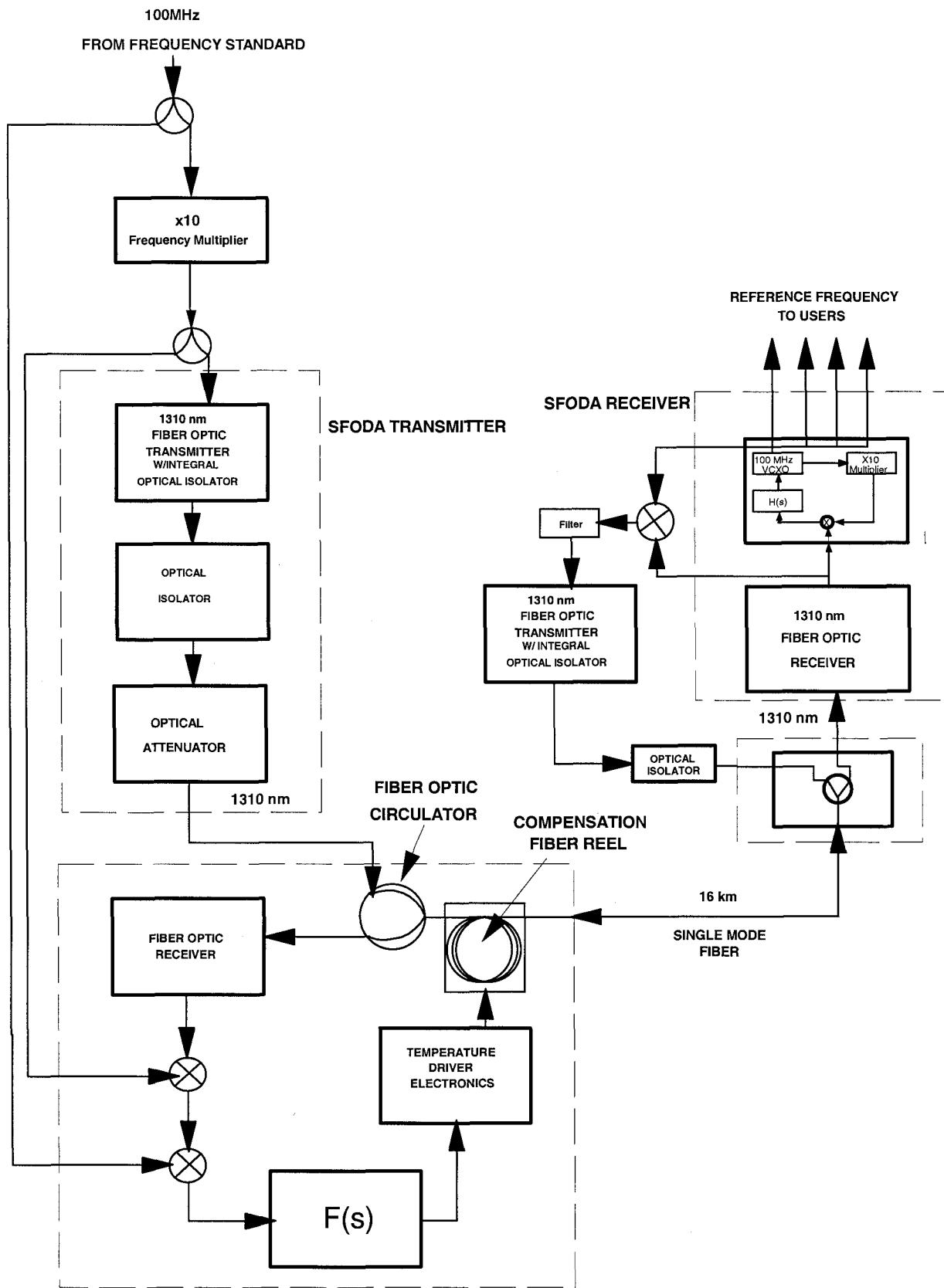

Figure 4. Block diagram of the Stabilized Fiber Optic Distribution Assembly.

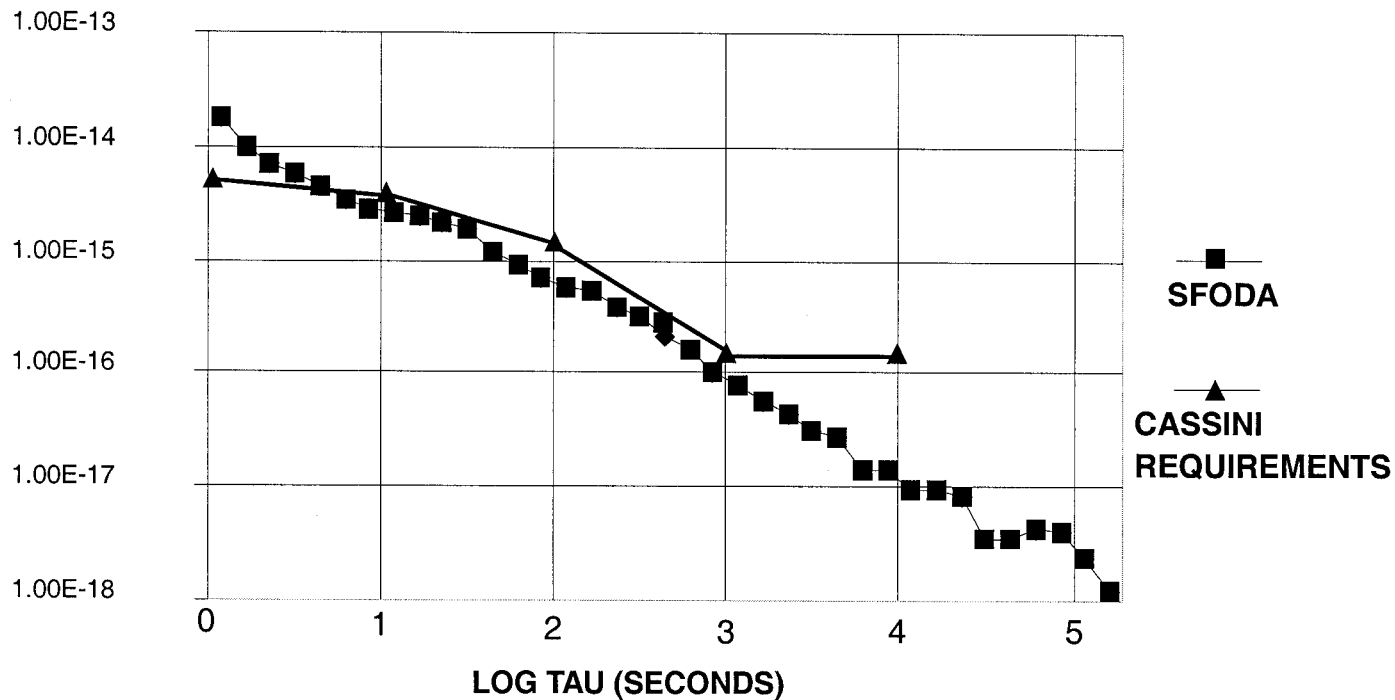

Figure 5. Allan Deviation of SFODA 100 MHz reference frequency over 16 km fiber link during 1 degree C peak to peak thermal cycling in an environmental chamber.

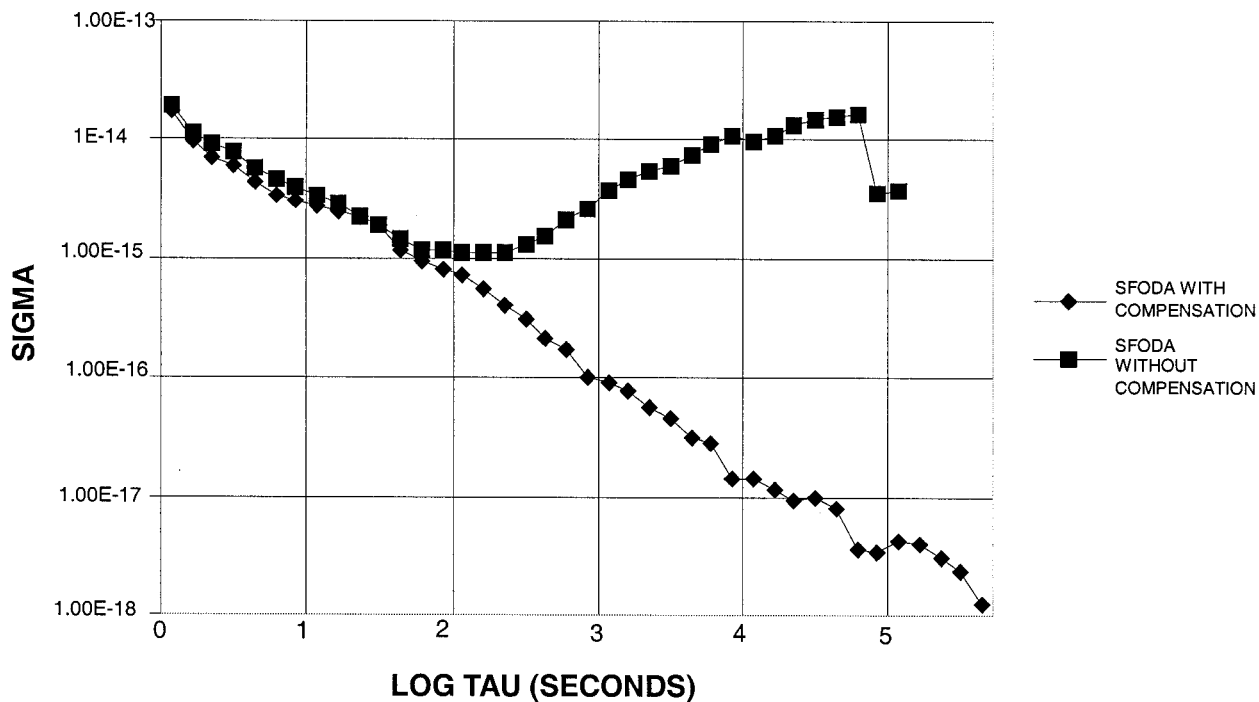

Figure 6. Allan Deviation of the SFODA with and without active phase compensation during 1 degree C peak to peak thermal cycling in an environmental chamber at a period of 24 hours.

CSO Phase Noise Performance

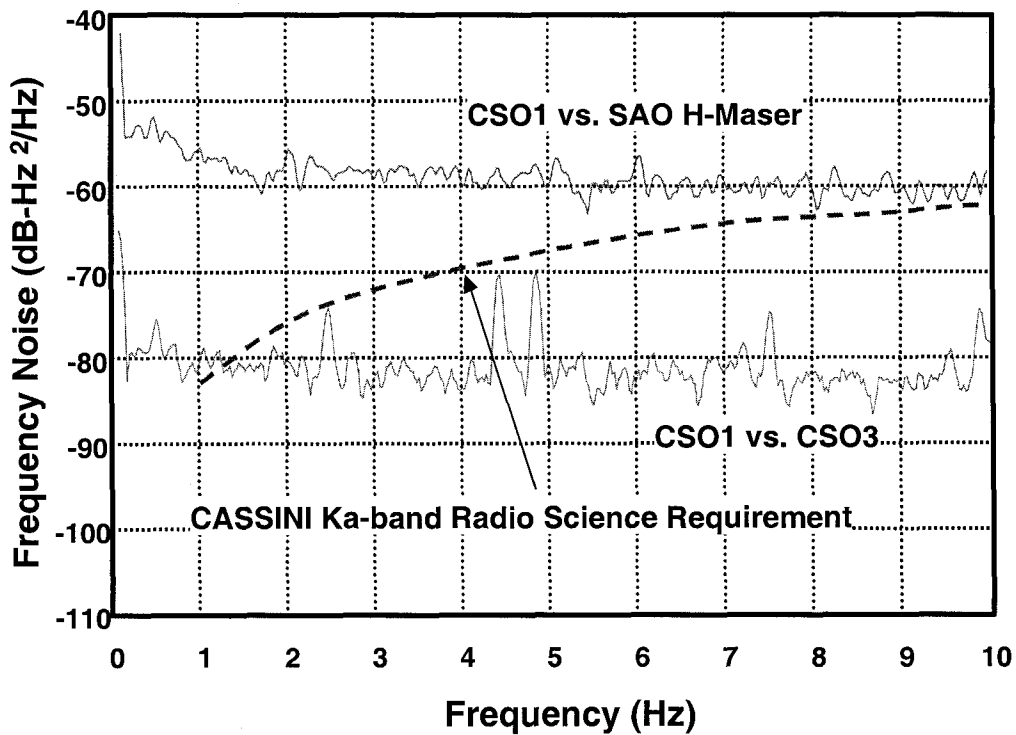

Figure 7. Compensated Sapphire Oscillator (CSO) Phase Noise Performance as measured a) against a hydrogen maser and b) a second CSO.

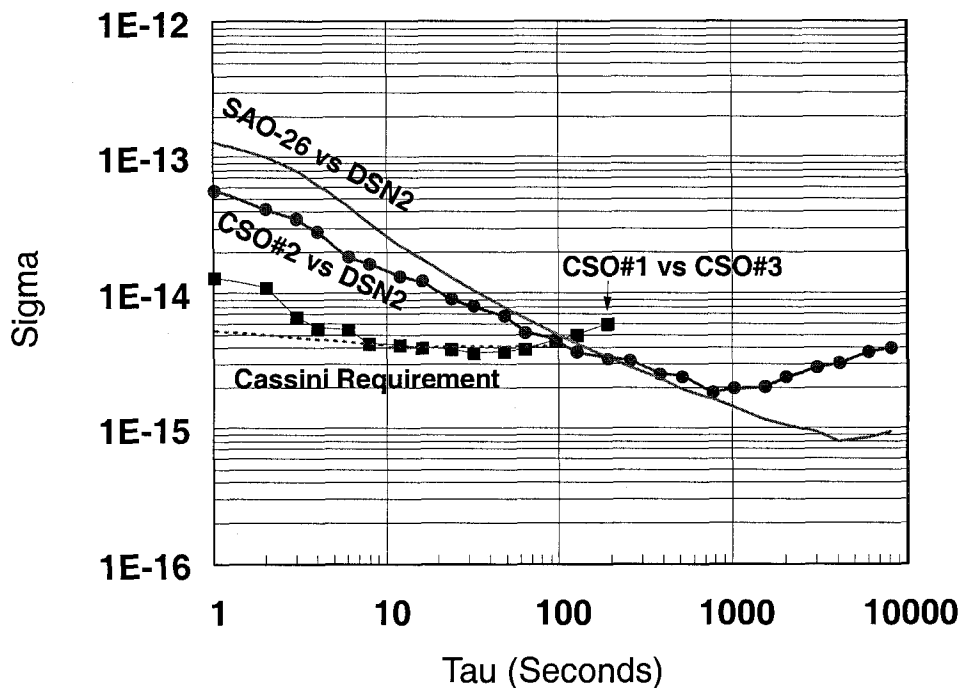

Figure 8. Compensated Sapphire Oscillator (CSO) Allan Deviation as measured against a) the hydrogen maser DSN2 and b) against a second CSO.